

# NITTA CORPORATION

4-4-26 Sakuragawa Naniwa-ku, Osaka 556-0022 Japan  
Phone:+81-6-6563-1225 Fax:+81-6-6563-1242  
<http://www.nitta.co.jp>



## NITTA CORPORATION OF AMERICA

7605 Nitta Drive, Suwanee, GA 30024, U.S.A.  
Phone:+1-770-497-0212 Fax:+1-770-623-1398  
<http://www.nitta.com>

## NITTA CORPORATION OF HOLLAND B.V.

Berenkoog 25, 1822 B.H. Alkmaar, The Netherlands  
Phone:+31-72-5622234 Fax:+31-72-5613238  
<http://www.nitta.nl>

## NITTA (SHANGHAI) MANAGEMENT CO., LTD

Room 2705, Shenggao International Building, No. 137 Xianxia Road, Shanghai 200051  
Phone:+86-21-6229-6000 Fax:+86-21-6229-9606  
<http://www.nitta-cn.com>

## NITTA CORPORATION INDIA PVT. LTD.

Gat No.186, Village Fulgaon, Taluka Haveli, Pune, Maharashtra 412216, INDIA  
Phone:+91-20-6731-3400 Fax:+91-20-6731-3401  
<http://www.nitta.co.in>

## NITTA CORPORATION KOREA OFFICE

Room 710, 7F, ShinhanDM Bldg. Mapo-daero 25, Mapo-gu, Seoul, Korea  
Phone:+82-2-3274-1252 Fax:+82-2-3274-1253  
<http://www.nitta.kr>

## NITTA INDUSTRIES EUROPE GmbH

Hansaallee 201, 40549 Dusseldorf, Germany  
Phone:49-211-537535-0 Fax:+49-211-537535-35  
<http://www.nitta.de>

## NITTA CORPORATION OF SINGAPORE PTE LTD

120 Lower Delta Road, #05-07/08  
Cendex Centre, Singapore 169208  
Phone:+65-6438-8738 Fax:+65-6438-8793  
<http://www.nitta.com.sg>  
<Thai Liaison Office>Phone:+66-2797-0723  
<Indonesia Liaison Office>Phone:+62-22-421-3146

## TAIWAN NITTA FILTER CO., LTD.

Headquarters: Chia Hsin Building 10FL Room No. 1005, 96 Chung Shan North Road Section 2, Taipei, Taiwan, R.O.C.  
Phone:+886-2-2581-6296 Fax:+886-3-469-0260  
<http://www.nitta.com.tw>

## NITTA BRASIL

Rua Francisco Mommenshon, 50B, Galpão 02  
Laranjeiras, Caieiras, São Paulo, Brazil  
Phone/Fax:+55-11-4441-2922  
<http://www.nitta.com.br>

## CONNECT CONVEYOR BELTING INC.

405 Industrial Drive Unit 3-8, Milton, Ontario Canada L9T 5B1  
Phone:+1-905-878-5552 FAX:+1-905-878-0344  
<http://www.connectbelting.com/>



SUPER ENDLESS BELT  
**SEB**<sup>TM</sup>

---

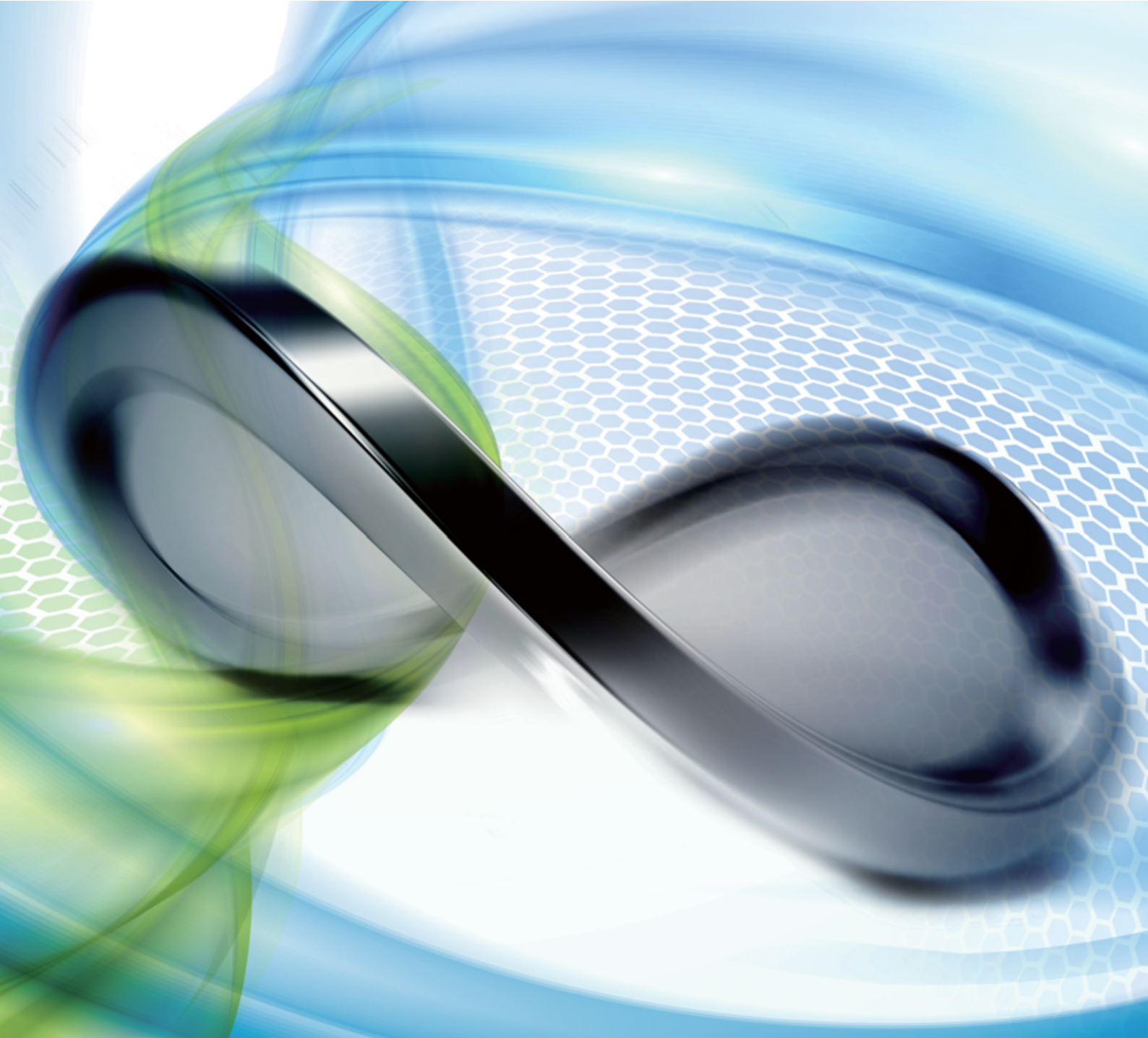

**NITTA CORPORATION**

Since entering the new century, automation has been progressing remarkably. To develop OA (Office Automation), FA (Factory Automation) and SA (Store Automation), further sophisticated equipment is needed.

Nitta Corporation has been continuously researching and developing SEB™ (Super Endless Belt) since its appearance on the market, giving first priority to customer satisfaction and meeting the demands of the times. As a result, the superior performance of SEB has produced high reliability.

In 1996, Nitta obtained ISO 9001 certification and is ready to supply products that fit the increasingly globalized world, through the appropriate quality assurance system.

We provide various types of belts to meet any of your demands.

## Table of Contents

Excellent Features .....	1
Major Applications .....	2
Belt Structure and Properties .....	3
List of Products .....	4 to 5
Types, Properties and Inner Peripheral Length	
Pinching Conveyor Belt N Series .....	6 to 7
Conveyor and Low-Load Power Transmission Belt G15 Series .....	8 to 9
Conveyor and Low-Load Power Transmission Belt G 30 Series .....	10 to 11
Conveyor and Medium-Load Power Transmission Belt F50 Series .....	12 to 13
Conveyor and Medium-Load Power Transmission Belt F100 Series .....	14 to 15
Medium-Load Power Transmission Belt XA/A Series .....	16 to 17
High-Load Power Transmission Belt B/D/GS Series .....	18 to 19
High-Temperature Conveyor and Low-Load Power Transmission Belt H50 Series .....	20 to 21
Selecting Belt	
Selecting Conditions/Procedures .....	22
Selecting Type/Structure .....	23
Design Materials	
Transmitted Power Correction Factor ( $K_1$ ) According to Load Change .....	24
Belt Type Selection Diagram and Traction Coefficient ( $\lambda$ ) .....	25
Calculation for Selecting Belt .....	26
Design Calculation .....	27 to 28
Formulas and Conversion Table .....	29
Calculating Belt Inner Peripheral Length .....	30
Belt Inner Peripheral Length Nomograph .....	31
Flat Pulley and Recommended Shape of Pulley .....	32 to 33
For Correct Use (Precautions for use) .....	34 to 35
Troubleshooting .....	36
For Safe Use of Products .....	37

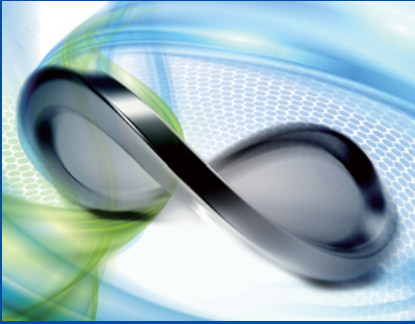

# SUPERB ENDLESS BELT

## Excellent Features

### 1 Seamless Belt

Molded seamless belt with excellent dimensional stability

### 2 High Revolution Accuracy

Stable pitch line of the seamless belt ensures high revolution accuracy.

### 3 Compatible with Small Pulley Diameter

Thin, highly flexible, bendable, abrasion resistant and durable; SEB provides superior performance when used for precision power transmission equipment and conveyors with small pulleys.

### 4 High Oil/Chemical Resistance

Highly resistant to almost all chemicals  
Suitable for a wide range of power transmission and conveyance

### 5 High Environmental Resistance

High resistance to environment including cold, heat and ozone  
Suitable for a wide range of uses

### 6 Maintenance Free

Excellent tension retaining properties  
Maintenance (belt replacement, etc.) unnecessary for a long time

### 7 A Variety of Types

You can select a belt appropriate for your use from a variety of belts with different surface materials, tension members, structures, etc.

# Suitable for Every Place and Every Use

## Major Applications

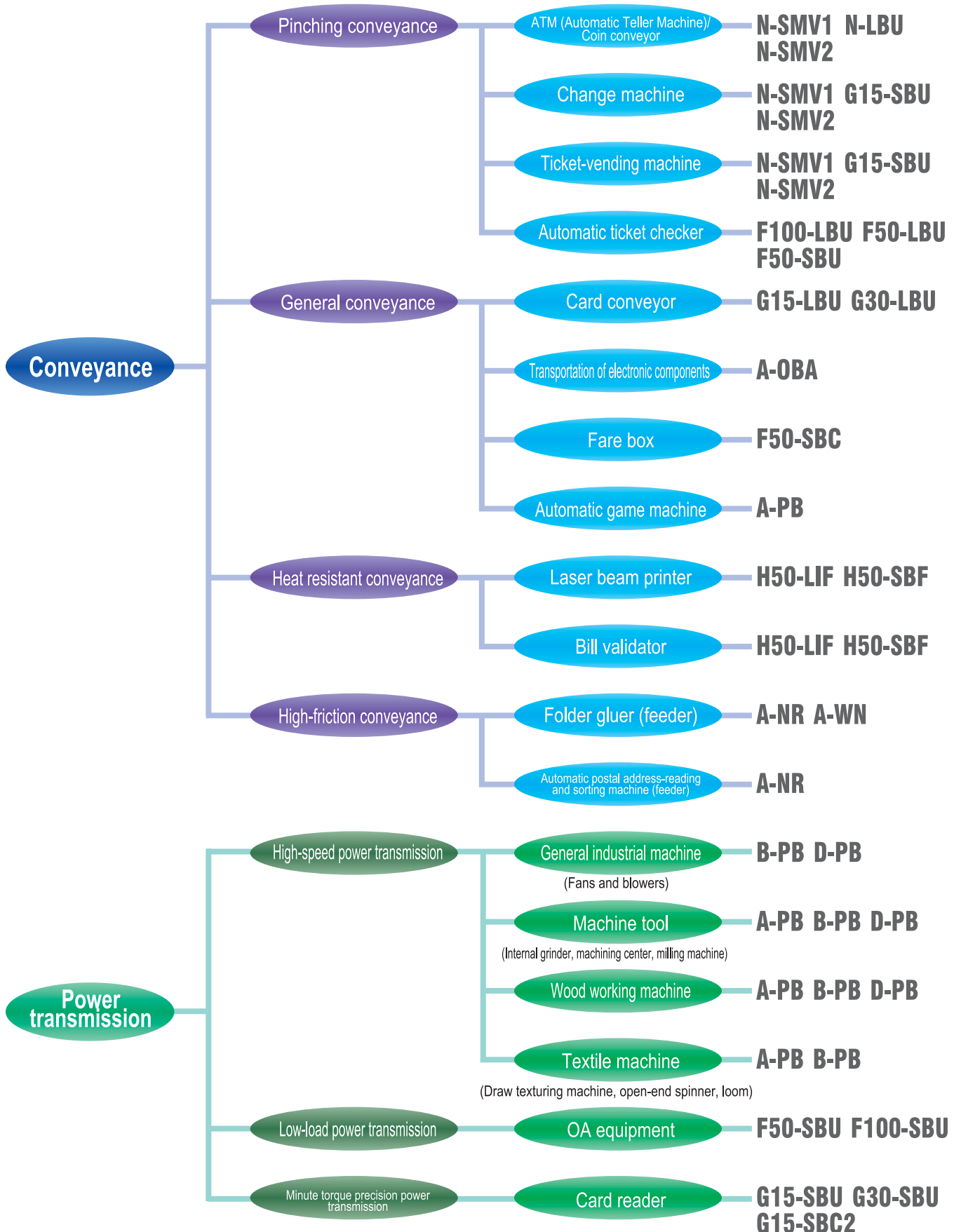

# Belt Structure and Properties

## N (G15/G30/F50/F100) -S□□ Type

[Belt cross section]

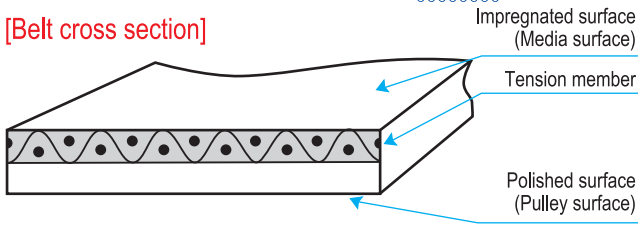

[Features]

[Conveying paper sheets pinched between belts]

- The tension member is on the impregnated surface side; there is not much difference between the belt speed and the media speed.
- The facing tension members are close to each other; even in a winding layout, there is not much difference among the belt speeds.
- Due to little difference among the speeds, sliding resistance (load caused by the pinching layout) is low, thus reducing power consumption of the machine.

[Labeling]

Example: **G15 - SBU** **15<sup>W</sup>** × **300<sup>L</sup>** × **0.65<sup>T</sup>**

↑ Series
↑ Structure
↑ Width (mm)
↑ Inner peripheral length (mm)
↑ Thickness (mm)
[Un necessary for the standard specification]

## N (G15/G30/F50/F100) -L□□ Type

[Belt cross section]

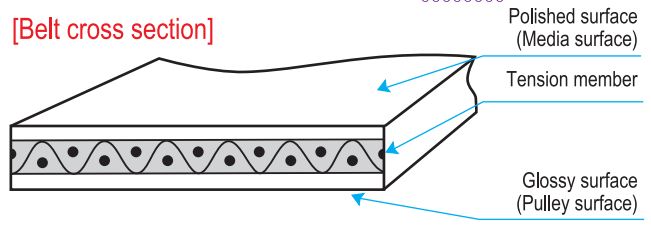

[Features]

[Conveying hard cards pinched between belts]

- When a card contacts with a belt at a sharp angle (on a pulley) during carrying-in/out, damage to the tension member is absorbed by the surface rubber.

## Rubber Properties by Belt Types

Belt Type		Properties					
		Crack resistance	Abrasion resistance	Oil resistance	Ozone resistance	Heat resistance	Antistatic property
N-SMV1,V2		●	●	●	●	▲	●
N-LBU		●	●	●	●	▲	○
G15, G30	-□BU	●	●	●	●	▲	○
F50	-□BC	●	○	○	●	○	●
F100	-□B	○~▲	●	●	▲	▲~○	●
H50		○	▲	●	●	●	×
XA, A, B, D	-PB	○~▲	●	●	▲	▲~○	●
A	-PC	●	○	○	●	○	●
A	-OBA	○~▲	●	●	▲	▲~○	●
B	-PSS	○~▲	●	●	▲	▲~○	●
GS	-OC	●	○	○	●	○	●
A	-NR (High friction against the conveyor surface)	×	▲ ※1	×	×	×	○
A	-WN (High friction against the conveyor surface)	×	▲ ※1	×	×	×	×

※ 1 Excellent as a feeder belt

● Especially excellent ○ Excellent ▲ Examination needed depending on use conditions × Poor





# A variety of products available to meet your

## List of Products (SEB™)

Major Applications	Tension member		Series	Type	Properties	Recommended elongation rate (%)
	Structure	Material				
	High-stretch seamless knit fabric	Polyester	N	LBU	● High stretch and high precision conveyance	5.0
				SMV1		
				SMV2		
	Seamless woven fabric	Polyester	G15	SBU	● High precision conveyance ● Minute torque power transmission ● Precision power transmission	2.0
				LBU		
				SBC1		
				SBC2		
				LBC		
				SB		
			G30	SBU	● High-precision conveyance ● Small torque power transmission ● Precision power transmission	2.0
				LBU		
				SBC1		
				SBC2		
				LBC		
				LB		
	Polyester	F50	SBU	● Low-load power transmission ● High-speed conveyance	2.0	
			LBU			
			SBC2			
LBC						
SB						
F100		SBU	● Low-load power transmission ● High-speed conveyance	2.0		
		LBU				
		SBC2				
		LBC				
		SB				
Cord	Polyester	XA	PB	● Low-torque, high-speed power transmission	1.0	
		A	PB	● Low-torque power transmission ● High-speed power transmission ● Low vibration	1.0	
			PC			
			OBA			
			NR			
	WN					
	B	PB	● Medium-torque power transmission ● High-speed power transmission	1.0		
		PSS				
	D	PB	● High-torque power transmission	1.0		
	Glass fiber	GS	OC	● High modulus ● Sliding conveyance	0.3	
Heat resistant, lightweight conveyance and power transmission	Seamless woven fabric	Special heat-resistant fiber	H50	LIF	● High-temperature conveyance ● High-temperature, low-torque power transmission	2.0
				SIF		
				LBF		

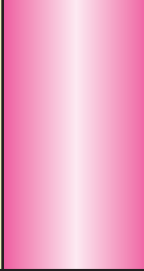
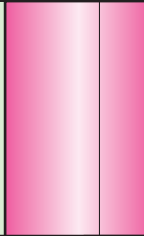
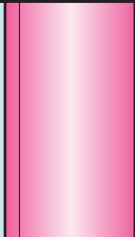
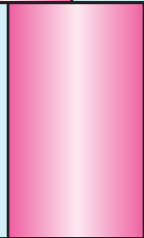
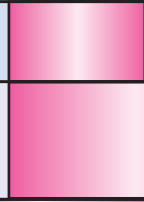
# needs accurately and efficiently

 Approximate range of use

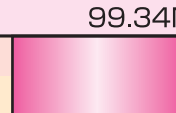
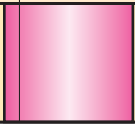
Breaking Strength (N/mm width)	Approximate Range of Standard Belt Transmitted Power (per 10 mm width)			Page
	1	10	10 <sup>2</sup>	
11.8	1.47N		4.12N	6 to 7
6.86				
9.31				
8.83	2.45N		6.86N	8 to 9
17.7	5.00N		13.6N	10 to 11
24.5	8.24N		22.75N	12 to 13
39.2	13.24N		36.38N	14 to 15
29.4	12.36N		34.12N	16 to 17
58.8	12.36N		68.25N	
118	6.18N		34.12N	18 to 19
235	49.62N		136.51N	
216	24.81N		68.25N	20 to 21
24.5	8.24N		22.75N	



# Pinching Conveyor Belt

## N Series

Feature: High-stretch, high-precision conveyor belt; easy installation available even in a complicated layout

Use: Pinching conveyance for ATM and ticket-vending machines

Cross Section

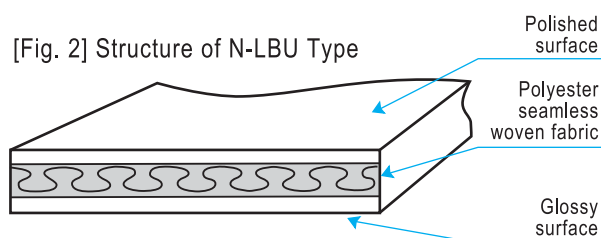
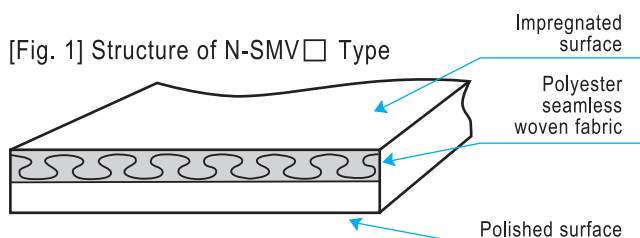

### ● Types and Properties

Item	N-SMV1	N-SMV2	N-LBU	
1 Structure	Fig. 1	Fig. 1	Fig. 2	
2 Available width (mm)	8~200	8~200	8~200	
3 Standard thickness (mm)	0.65	0.65	1.0	
4 Rubber material	Millable urethane	Millable urethane	Millable urethane	
5 Surface figure	Impregnated surface	Impregnated surface	Polished surface	
6 Pulley surface figure	Polished surface	Polished surface	Glossy surface	
7 Weight	8	8	12	
8 Breaking strength (N/mm width)	6.86	9.31	11.8	
9 Standard elongation rate (%)	5.0	5.0	5.0	
10 Axial load at the standard elongation rate under stable conditions (N/mm width)	0.88	1.18	0.98	
11 Friction coefficient	Top surface (against paper sheet)	0.3 to 0.6	0.3 to 0.6	0.4 to 0.8
	Bottom surface (against SUS)	0.4 to 0.8	0.4 to 0.8	0.5 to 1.0
12 Minimum pulley diameter (mm)	φ8	φ8	φ10	
13 Operating temperature range	-20 to +60	-20 to +60	-20 to +60	

# Standard Dimensional Tolerance

(1) Width (mm)

Width	Tolerance
8 or more and less than 11	±0.3
11 or more and less than 21	±0.5
21 or more and less than 101	±1.0
101 or more	±1.5

(2) Thickness (mm)

Thickness	Tolerance
0.6 or more and less than 0.8	±0.05
0.8 or more and less than 1.0	±0.06
1.0 or more	±0.10

(3) N-SMV1/SMV2 (Thickness: 0.65 mm): List of Inner Peripheral Lengths (mm)

Less than 200			200 or more and less than 300		300 or more and less than 500			500 or more and less than 800			800 or more and less than 1100		1100 or more	
Tolerance: ± 2			Tolerance: ± 3		Tolerance: ± 4			Tolerance: ± 6			Tolerance: ± 7		Tolerance: ± 0.8 %	
80.0	120.0	155.0	201.0	248.0	300.0	362.0	425.0	503.0	593.0	724.0	804.0	1033.0	1108.0	1504.0
82.0	123.0	156.0	202.0	249.0	301.0	367.0	426.0	505.0	595.0	734.0	820.0	1048.0	1123.0	1543.0
84.0	125.0	160.0	204.0	251.0	304.0	371.0	427.0	510.0	600.0	740.0	835.0	1057.0	1143.0	1558.0
86.0	127.0	161.0	205.0	252.0	305.0	372.0	429.0	519.0	604.0	747.0	854.0	1066.0	1149.0	
90.0	128.0	163.0	206.0	254.0	306.0	376.0	431.0	522.0	607.0	754.0	855.0	1072.0	1150.0	
93.0	129.0	164.0	208.0	256.0	309.0	381.0	437.0	529.0	614.0	756.0	856.0	1073.0	1171.0	
97.0	130.0	167.0	212.0	261.0	310.0	384.0	443.0	533.0	619.0	760.0	862.0	1078.0	1181.0	
100.0	132.0	168.0	213.0	264.0	310.0	384.0	443.0	533.0	619.0	760.0	862.0	1078.0	1181.0	
100.0	132.0	168.0	214.0	267.0	313.0	388.0	447.0	536.0	630.0	765.0	873.0	1080.0	1198.0	
101.0	133.0	171.0	218.0	270.0	318.0	390.0	452.0	537.0	639.0	770.0	882.0	1088.0	1208.0	
103.0	135.0	173.0	222.0	272.0	320.0	391.0	454.0	542.0	642.0	775.0	883.0	1096.0	1213.0	
104.0	138.0	176.0	222.5	275.0	322.0	393.0	457.0	545.0	653.0	790.0	904.0		1238.0	
106.0	139.0	177.0	223.0	277.0	325.0	397.0	458.0	548.0	655.0		914.0		1259.0	
107.0	139.5	180.0	225.0	278.0	326.0	402.0	459.0	552.0	661.0		919.0		1270.0	
107.0	139.5	180.0	228.0	282.0	326.0	402.0	459.0	552.0	661.0		919.0		1270.0	
108.0	140.0	181.0	230.0	283.0	328.0	406.0	464.0	557.0	665.0		941.0		1279.0	
110.0	142.0	182.0	235.0	285.0	329.0	410.0	467.0	559.0	669.0		956.0		1309.0	
111.0	143.0	184.0	237.0	285.5	330.0	411.0	468.0	563.5	674.0		966.0		1317.0	
112.0	144.0	186.0	238.0	286.0	332.0	412.0	470.0	564.0	680.0		979.0		1341.0	
113.0	145.0	190.0	240.0	287.0	339.0	414.0	474.0	572.0	689.0		986.0		1356.0	
114.0	146.0	192.0	241.0	288.0	345.0	416.0	482.0	578.0	697.0		1001.0		1405.0	
115.0	149.0	193.0	243.5	290.0	349.0	420.0	493.0	583.0	700.0		1007.0		1425.0	
116.0	150.0	195.0	244.0	292.0	350.0	421.0	495.0	586.0	704.0		1022.0		1441.0	
117.0	151.0	199.0	246.0	297.0	352.0	423.0		589.0	711.0		1027.0		1457.0	
117.0	151.0	199.0	246.5	299.0	352.0	423.0		589.0	711.0		1027.0		1457.0	
118.0	154.0		247.0		358.0	424.0		590.0	712.0		1029.0		1488.0	

(4) N-LBU (Thickness: 1.0 mm): List of Inner Peripheral Lengths (mm)

Less than 200			200 or more and less than 300		300 or more and less than 500			500 or more and less than 800			800 or more and less than 1100		1100 or more	
Tolerance: ± 2			Tolerance: ± 3		Tolerance: ± 4			Tolerance: ± 6			Tolerance: ± 7		Tolerance: ± 0.8 %	
82.5	121.0	160.0	201.5	252.5	300.0	365.5	427.5	506.5	597.0	716.5	809.0	1063.0	1102.0	1495.0
84.0	121.5	162.5	203.5	254.0	302.5	371.0	428.5	508.5	599.5	728.5	824.5	1071.5	1113.5	1511.0
86.0	125.0	164.0	205.0	255.0	303.0	374.0	429.0	514.0	604.0	738.5	840.0	1077.0	1128.5	1550.0
88.0	127.5	166.0	207.5	257.5	304.5	375.0	430.0	523.0	608.0	745.0	859.0	1079.0	1149.0	1565.0
93.0	129.0	167.0	208.5	259.5	307.0	376.0	433.0	523.5	611.0	751.5	859.5	1083.0	1155.0	
95.5	131.0	170.0	211.5	264.0	309.0	380.0	435.0	526.5	618.5	759.0	866.5	1085.5	1156.0	
96.5	132.5	171.0	214.5	266.5	309.0	380.0	435.0	526.5	618.5	759.0	866.5	1085.5	1156.0	
96.5	132.5	171.0	215.5	270.5	310.0	385.0	441.0	533.0	623.5	764.0	878.5	1094.0	1177.0	
99.5	134.5	174.0	216.5	273.5	312.5	388.0	447.0	538.0	634.5	770.0	886.5		1187.0	
103.0	136.0	176.0	217.5	275.5	316.0	391.0	451.0	540.5	640.5	773.0	909.0		1204.5	
104.0	138.0	179.0	220.5	277.5	321.5	393.5	456.0	546.0	643.0	779.5	919.0		1214.0	
106.0	140.5	180.5	224.5	280.5	323.0	397.0	458.0	549.0	646.5	794.0	923.5		1219.5	
106.5	141.5	183.5	225.5	281.0	325.0	400.0	460.5	552.0	657.0		946.0		1244.0	
108.5	142.0	184.5	228.5	284.5	328.5	401.0	463.0	556.5	659.0		961.0		1265.0	
109.0	143.0	187.5	231.5	285.0	329.0	405.5	467.5	561.0	665.0		972.0		1276.0	
111.0	145.0	189.5	233.0	286.5	331.5	409.0	471.0	562.5	669.5		974.0		1285.0	
112.0	146.0	192.5	238.5	288.0	332.0	413.5	474.0	563.0	673.5		991.0		1315.5	
113.0	147.5	194.5	239.0	288.5	335.0	415.0	478.0	567.5	678.0		1007.0		1323.5	
114.5	149.0	196.0	241.5	290.0	342.0	416.0	486.0	568.0	684.0		1012.0		1347.0	
115.5	152.0	197.5	243.5	291.0	349.0	417.0	496.5	576.5	693.0		1027.0		1362.0	
116.0	153.0		244.0	293.5	353.0	419.0	499.0	582.0	701.0		1032.5		1412.0	
117.5	153.5		249.0		354.0	423.0		587.5	704.5		1034.5		1432.0	
119.0	156.5		249.5		355.0	425.0		590.0	709.0		1038.5		1447.0	
119.5	158.0		250.5		361.0	426.5		593.5	716.0		1053.5		1464.0	

\* If you wish to order a product with a size other than the standard, consult us.

\* SEB is built to order; the minimum order quantity is one lot. For details, contact our agencies or our sales representative.

# Conveyor and Low-Load Power Transmission Belt

## G15 Series

**Feature:** This belt, which uses thin, polyester seamless woven fabric as a tension member, is applied to conveyance and low-load power transmission.  
**Use:** ATM, copy machine sorters, minute-torque precision power transmission, OA equipment, etc.

### Cross Section

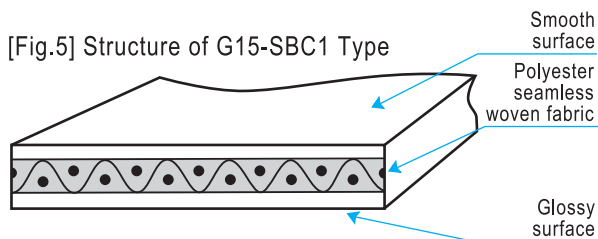
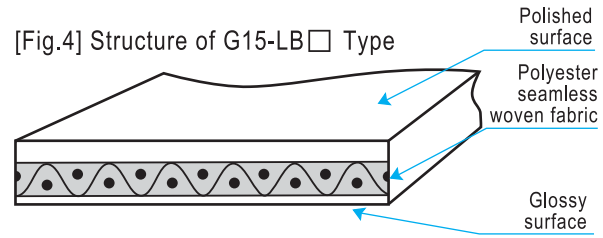
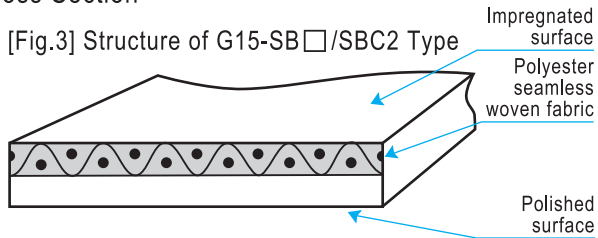

### ● Types and Properties

Item	G15-SBU	G15-LBU	G15-SBC1	G15-SBC2	G15-LBC	G15-SB	G15-LB	
1 Structure	Fig. 3	Fig. 4	Fig. 5	Fig. 3	Fig. 4	Fig. 3	Fig. 4	
2 Available width (mm)	3to200	3to200	3to200	3to200	3to200	3to200	3to200	
3 Standard thickness (mm)	0.65	1.0	0.43	0.6	1.0	0.65	1.0	
4 Rubber material	Millable urethane	Millable urethane	Chloroprene rubber	Chloroprene rubber	Chloroprene rubber	Nitrile rubber	Nitrile rubber	
5 Surface figure	Impregnated surface	Polished surface	Smooth surface	Impregnated surface	Polished surface	Impregnated surface	Polished surface	
6 Pulley surface figure	Polished surface	Glossy surface	Glossy surface	Polished surface	Glossy surface	Polished surface	Glossy surface	
7 Weight	6.5	10	4.5	6	10	6.5	10	
8 Breaking strength (N/mm width)	8.83	8.83	8.83	8.83	8.83	8.83	8.83	
9 Standard elongation rate (%)	2.0	2.0	2.0	2.0	2.0	2.0	2.0	
10 Axial load at the standard elongation rate under stable conditions (N/mm width)	1.47	1.47	1.47	1.47	1.47	1.47	1.47	
11 Friction coefficient (against SUS)	Top surface	0.3 to 0.6	0.4 to 0.8	0.4 to 0.9	0.3 to 0.6	0.4 to 0.8	0.3 to 0.6	0.4 to 0.8
	Pulley surface	0.4 to 0.8	0.5 to 1.0	0.4 to 0.9	0.4 to 0.8	0.5 to 1.0	0.4 to 0.8	0.5 to 1.0
12 Minimum pulley diameter (mm)	φ6	φ10	φ5	φ6	φ10	φ8	φ15	
13 Operating temperature range	-20 to +60	-20 to +60	-20 to +80	-20 to +80	-20 to +80	-20 to +80	-20 to +80	

# Standard Dimensional Tolerance

## (1) Width (mm)

Width	Tolerance
3 or more and less than 11	±0.3
11 or more and less than 21	±0.5
21 or more and less than 101	±1.0
101 or more	±1.5

## (2) Thickness (mm) \*For G15-SBC, only

Thickness	Tolerance
※0.43	±0.05
0.6 or more and less than 0.8	±0.05
0.8 or more and less than 1.0	±0.06
1.0 or more	±0.10

## (3) G15-SB/SBU/SBC2/G30-SBC\* Type: List of Inner Peripheral Lengths (mm)

\*See (3) of P. 11.

Inner peripheral length of less than 300				300 or more and less than 500			500 or more and less than 700		700 or more and less than 900	900 or more and less than 1100	1100 or more
Tolerance: ± 2 mm				Tolerance: ± 3 mm			Tolerance: ± 4 mm		Tolerance: ± 4.5 mm	Tolerance: ± 5.5 mm	Tolerance: ± 0.5 %
97.0	138.0	186.0	247.0	300.0	373.5	455.0	504.0	601.5	702.0	906.5	1111.0
100.5	139.0	190.0	247.5	300.5	377.5	458.0	506.0	605.5	706.5	916.5	1126.0
101.0	139.5	192.0	250.0	302.0	382.0	460.5	511.0	608.5	713.0	920.5	1146.5
103.5	140.5	193.5	251.5	304.5	385.5	465.0	511.5	616.0	714.0	943.5	1152.0
104.0	142.0	195.0	252.5	306.0	389.0	468.5	520.0	621.0	726.0	958.5	1153.5
105.5	143.5	198.5	255.0	307.0	391.5	471.5	520.5	632.0	736.0	969.0	1174.5
106.5	145.0	201.0	256.5	310.0	394.5	475.5	524.0	640.5	741.5	982.0	1184.5
108.5	146.0	202.5	261.0	313.5	398.5	483.5	530.0	644.0	742.5	988.5	1202.0
109.5	149.5	205.5	264.5	319.0	403.0	494.0	535.0	654.5	749.0	1004.5	1211.5
110.5	150.5	206.0	267.5	320.5	406.5	496.0	538.0	656.5	756.5	1009.0	1217.0
112.5	151.0	209.0	271.0	322.5	411.0		543.5	662.5	761.5	1024.5	1241.5
113.5	154.0	212.0	273.0	325.5	412.5		546.5	667.0	767.5	1030.0	1262.5
114.0	156.0	213.5	275.5	326.5	413.5		549.5	671.0	770.5	1032.0	1273.5
115.0	157.5	215.0	277.5	329.0	414.5		554.0	675.5	777.0	1036.0	1282.5
116.5	160.0	218.0	278.5	329.5	416.5		558.0	681.5	791.5	1051.0	1313.0
117.5	161.5	222.0	282.5	330.0	420.5		558.5	681.5	806.5	1060.5	1321.0
118.5	163.5	223.0	284.0	332.5	422.5		560.0	690.5	822.0	1069.0	1344.5
120.0	164.5	226.0	285.0	339.5	425.0		560.5	698.5	837.5	1074.5	1359.5
123.0	167.0	229.0	286.0	346.0	426.0		565.0		856.5	1076.5	1409.0
125.0	168.0	230.5	287.5	350.5	426.5		565.5		857.0	1081.0	1429.5
127.0	171.0	236.0	288.5	351.0	427.5		573.5		864.5	1083.0	1445.0
128.5	173.5	237.0	291.0	352.5	430.5		579.5		876.0	1091.0	1461.5
129.5	176.0	238.5	292.5	358.5	432.5		585.0		884.0	1099.5	1492.5
130.0	177.5	240.5	297.5	363.0	438.5		587.5				1508.5
132.0	180.5	241.5		368.5	444.5		591.0				1547.5
133.5	182.0	244.5		372.0	448.5		594.5				1562.5
135.5	185.0	246.5		372.5	453.0		597.0				

## (4) G15-LB□/SBC1 Type: List of Inner Peripheral Lengths (mm)

Inner peripheral length of less than 300				300 or more and less than 500			500 or more and less than 700		700 or more and less than 900	900 or more and less than 1100	1100 or more
Tolerance: ± 2 mm				Tolerance: ± 3 mm			Tolerance: ± 4 mm		Tolerance: ± 4.5 mm	Tolerance: ± 5.5 mm	Tolerance: ± 0.5 %
98.5	139.5	188.0	246.0	301.5	375.0	455.0	505.5	610.0	700.0	908.0	1101.0
102.0	140.5	191.5	248.0	302.0	379.0	456.5	507.5	617.5	703.5	918.0	1112.5
102.5	141.5	193.5	248.5	303.5	384.0	459.5	513.0	622.5	708.0	922.5	1127.5
105.0	142.0	195.0	249.0	306.0	387.0	462.0	522.0	633.5	715.0	945.0	1148.0
105.5	144.0	196.5	251.5	308.5	390.5	466.5	522.5	642.0	715.5	960.0	1154.0
107.5	145.0	200.5	253.0	309.0	393.0	470.0	525.5	645.5	727.5	971.0	1155.0
108.0	146.5	202.5	254.0	311.5	396.0	473.0	532.0	656.0	737.5	984.0	1176.0
110.0	148.0	204.0	256.5	315.0	400.0	477.0	537.0	658.0	744.0	990.0	1186.0
111.5	151.0	205.0	258.5	320.5	404.5	485.0	539.5	664.0	750.5	1006.0	1203.5
112.5	152.0	206.5	263.0	322.0	408.0	495.5	545.0	668.5	758.0	1010.5	1213.0
114.0	152.5	207.5	265.5	324.0	412.5	498.0	548.0	672.5	763.0	1026.0	1218.5
114.5	155.5	210.5	269.5	327.5	414.0		551.0	677.0	769.0	1030.0	1243.0
115.0	157.5	213.5	272.5	328.0	415.0		555.5	683.0	772.0	1033.5	1264.0
116.5	159.0	214.5	274.5	330.5	416.0		560.0	692.0	778.5	1037.5	1275.0
118.0	161.5	215.5	277.0	331.0	418.0		561.0		793.0	1052.5	1284.0
119.0	163.0	216.5	279.5	332.0	422.0		561.5		808.0	1062.0	1314.5
120.0	165.0	219.5	280.0	334.0	424.0		566.5		823.5	1070.5	1322.5
121.0	166.0	223.5	284.0	341.0	425.5		567.0		839.0	1076.0	1346.0
124.5	169.0	224.5	285.5	348.0	426.5		575.5		858.5	1078.0	1361.0
126.5	170.0	227.5	287.0	352.0	427.5		581.0		866.0	1082.0	1411.0
128.5	172.5	230.5	287.5	353.0	428.0		586.5		877.5	1084.5	1431.0
130.0	175.0	232.0	289.0	354.0	429.0		589.0		885.5	1093.0	1446.5
131.0	177.5	237.5	290.0	360.0	432.0		592.5				1463.0
131.5	179.5	238.5	292.5	364.5	434.0		596.0				1494.0
133.5	182.5	240.5	294.0	370.0	440.0		598.5				1510.0
135.0	184.0	242.5	299.0	373.0	446.0		603.0				1549.0
137.0	186.5	243.0		374.0	450.0		607.0				1564.0

\*If you wish to order a product with a size other than the standard, consult us.

\*SEB is built to order; the minimum order quantity is one lot. For details, contact our agencies or our sales representative

# Conveyor and Low-Load Power Transmission Belt

## G30 Series

Feature: This belt, which uses thin, polyester seamless woven fabric as a tension member, is applied to conveyance and low-load power transmission.

Use: ATM, copy machine sorters, minute-torque precision power transmission, OA equipment, etc.

Cross Section

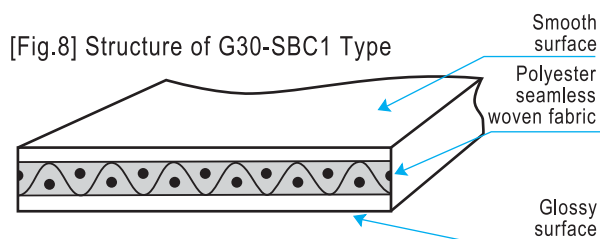
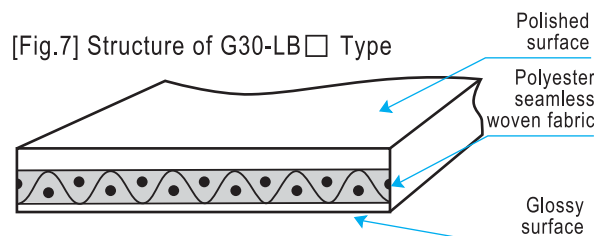
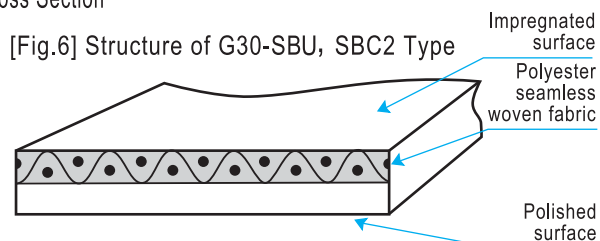

### ● Types and Properties

Item	G30-SBU	G30-LBU	G30-SBC1	G30-SBC2	G30-LBC	G30-LB	
1 Structure	Fig. 6	Fig. 7	Fig. 8	Fig. 6	Fig. 7	Fig. 7	
2 Available width (mm)	3to200	3to200	3to200	3to200	3to200	3to200	
3 Standard thickness (mm)	0.8	1.0	0.5	0.6	1.0	1.0	
4 Rubber material	Millable urethane	Millable urethane	Chloroprene rubber	Chloroprene rubber	Chloroprene rubber	Nitrile rubber	
5 Surface figure	Impregnated surface	Polished surface	Smooth surface	Impregnated surface	Polished surface	Polished surface	
6 Pulley surface figure	Polished surface	Glossy surface	Glossy surface	Polished surface	Glossy surface	Glossy surface	
7 Weight	8	10	5	6	10	10	
8 Breaking strength (N/mm width)	17.7	17.7	17.7	17.7	17.7	17.7	
9 Standard elongation rate (%)	2.0	2.0	2.0	2.0	2.0	2.0	
10 Axial load at the standard elongation rate under stable conditions (N/mm width)	2.94	2.94	2.94	2.94	2.94	2.94	
11 Friction coefficient (against SUS)	Top surface	0.3 to 0.6	0.4 to 0.8	0.4 to 0.9	0.3 to 0.6	0.4 to 0.8	0.4 to 0.8
	Pulley surface	0.4 to 0.8	0.5 to 1.0	0.4 to 0.9	0.4 to 0.8	0.5 to 1.0	0.5 to 1.0
12 Minimum pulley diameter (mm)	φ8	φ10	φ5	φ6	φ10	φ15	
13 Operating temperature range	-20to+60	-20to+60	-20to+80	-20to+80	-20to+80	-20to+80	

# Standard Dimensional Tolerance

(1) Width (mm)

Width	Tolerance
3 or more and less than 11	±0.3
11 or more and less than 21	±0.5
21 or more and less than 101	±1.0
101 or more	±1.5

(2) Thickness (mm) \*For G30-SBC1 only

Thickness	Tolerance
※0.50	±0.05
0.6 or more and less than 0.8	±0.05
0.8 or more and less than 1.0	±0.06
1.0 or more	±0.10

(3) G30-SBU (Thickness: 0.8 mm) Type: List of Inner Peripheral Lengths (mm)

\*For G30-SBC2, see (3) of P. 9.

Less than 300				300 or more and less than 500			500 or more and less than 700		700 or more and less than 900	900 or more and less than 1100	1100 or more
Tolerance: ± 2 mm				Tolerance: ± 3 mm			Tolerance: ± 4 mm		Tolerance: ± 4.5 mm	Tolerance: ± 5.5 mm	Tolerance: ± 0.5 %
96.5	137.5	190.5	247.0	301.0	385.0	460.0	502.5	631.5	701.0	905.0	1108.0
99.0	138.0	192.5	249.0	303.5	388.0	463.5	504.5	639.5	706.0	914.5	1123.5
100.0	139.5	194.0	250.0	305.5	389.5	467.5	510.5	643.0	712.5	920.0	1144.0
102.0	141.5	198.0	251.5	307.0	393.5	470.5	518.5	654.0	713.0	942.5	1150.0
102.5	142.0	200.0	254.5	309.0	397.5	475.0	522.5	655.0	725.0	958.0	1150.5
104.5	143.5	201.5	256.0	313.0	402.0	482.5	529.0	660.5	735.0	967.5	1171.5
106.0	145.5	205.0	259.5	318.0	405.5	493.0	533.0	666.0	742.0	980.5	1181.5
107.5	149.0	206.0	260.0	319.0	410.0	495.0	537.5	670.0	748.0	987.5	1199.5
108.5	150.0	208.0	263.5	321.5	411.0		543.0	674.5	755.5	1004.0	1208.5
110.0	150.5	211.5	266.5	325.5	412.5		545.5	681.0	760.5	1008.0	1214.5
111.5	153.5	213.0	270.0	326.0	413.5		548.5	690.0	765.5	1022.5	1239.5
112.5	154.0	213.5	272.0	328.0	414.0		552.5	698.0	770.5	1029.0	1261.0
113.0	157.0	217.0	274.0	329.0	415.5		558.0		776.0	1031.0	1271.0
114.0	158.5	221.0	276.5	332.0	419.0		560.0		790.5	1033.5	1280.5
115.0	160.5	222.0	278.0	339.0	422.0		563.5		805.5	1048.5	1310.5
117.0	162.5	225.0	281.0	345.5	424.5		573.5		821.0	1058.0	1318.5
118.0	163.5	228.0	283.0	349.5	425.0		578.5		836.0	1068.0	1343.0
119.5	166.5	229.5	284.5	350.0	426.0		584.0		856.0	1074.0	1358.5
122.5	167.5	234.5	285.0	351.5	427.0		587.0		863.0	1075.0	1407.0
124.5	170.5	236.0	286.0	358.0	430.0		590.0		874.5	1079.0	1427.5
126.0	172.0	238.0	288.0	361.5	431.5		593.5		883.5	1081.5	1442.5
127.5	175.5	240.0	290.0	368.0	438.0		596.0			1088.5	1459.0
128.5	177.0	240.5	292.0	372.0	443.0		600.5			1097.0	1489.5
129.0	180.0	244.0	297.0	372.5	447.5		604.5				1505.5
130.5	181.0	245.5	299.0	374.0	451.0		607.5				1545.0
132.5	184.0	246.0	299.5	377.0	454.5		615.0				1560.0
134.5	189.0	246.5		381.5	457.0		620.0				

(4) G30-LB□/SBC1 Type: List of Inner Peripheral Lengths (mm)

Less than 300				300 or more and less than 500			500 or more and less than 700		700 or more and less than 900	900 or more and less than 1100	1100 or more
Tolerance: ± 2 mm				Tolerance: ± 3 mm			Tolerance: ± 4 mm		Tolerance: ± 4.5 mm	Tolerance: ± 5.5 mm	Tolerance: ± 0.5 %
98.5	139.5	188.0	246.0	301.5	375.0	455.0	505.5	610.0	700.0	908.0	1101.0
102.0	140.5	191.5	248.0	302.0	379.0	456.5	507.5	617.5	703.5	918.0	1112.5
102.5	141.5	193.5	248.5	303.5	384.0	459.5	513.0	622.5	708.0	922.5	1127.5
105.0	142.0	195.0	249.0	306.0	387.0	462.0	522.0	633.5	715.0	945.0	1148.0
105.5	144.0	196.5	251.5	308.5	390.5	466.5	522.5	642.0	715.5	960.0	1154.0
107.5	145.0	200.5	253.0	309.0	393.0	470.0	525.5	645.5	727.5	971.0	1155.0
108.0	146.5	202.5	254.0	311.5	396.0	473.0	532.0	656.0	737.5	984.0	1176.0
110.0	148.0	204.0	256.5	315.0	400.0	477.0	537.0	658.0	744.0	990.0	1186.0
111.5	151.0	205.0	258.5	320.5	404.5	485.0	539.5	664.0	750.5	1006.0	1203.5
112.5	152.0	206.5	263.0	322.0	408.0	495.5	545.0	668.5	758.0	1010.5	1213.0
114.0	152.5	207.5	265.5	324.0	412.5	498.0	548.0	672.5	763.0	1026.0	1218.5
114.5	155.5	210.5	269.5	327.5	414.0		551.0	677.0	769.0	1030.0	1243.0
115.0	157.5	213.5	272.5	328.0	415.0		555.5	683.0	772.0	1033.5	1264.0
116.5	159.0	214.5	274.5	330.5	416.0		560.0	692.0	778.5	1037.5	1275.0
118.0	161.5	215.5	277.0	331.0	418.0		561.0		793.0	1052.5	1284.0
119.0	163.0	216.5	279.5	332.0	422.0		561.5		808.0	1062.0	1314.5
120.0	165.0	219.5	280.0	334.0	424.0		566.5		823.5	1070.5	1322.5
121.0	166.0	223.5	284.0	341.0	425.5		567.0		839.0	1076.0	1346.0
124.5	169.0	224.5	285.5	348.0	426.5		575.5		858.5	1078.0	1361.0
126.5	170.0	227.5	287.0	352.0	427.5		581.0		866.0	1082.0	1411.0
128.5	172.5	230.5	287.5	353.0	428.0		586.5		877.5	1084.5	1431.0
130.0	175.0	232.0	289.0	354.0	429.0		589.0		885.5	1093.0	1446.5
131.0	177.5	237.5	290.0	360.0	432.0		592.5				1463.0
131.5	179.5	238.5	292.5	364.5	434.0		596.0				1494.0
133.5	182.5	240.5	294.0	370.0	440.0		598.5				1510.0
135.0	184.0	242.5	299.0	373.0	446.0		603.0				1549.0
137.0	186.5	243.0		374.0	450.0		607.0				1564.0

\* If you wish to order a product with a size other than the standard, consult us.  
 \* SEB is built to order; the minimum order quantity is one lot.

# Conveyor and Medium-Load Power Transmission Belt

## F50 Series

Feature: This belt, which uses polyester seamless woven fabric as a tension member, is applied to conveyance and power transmission.

Use: OA equipment, ticket-vending machines, ATM, etc.

Cross Section

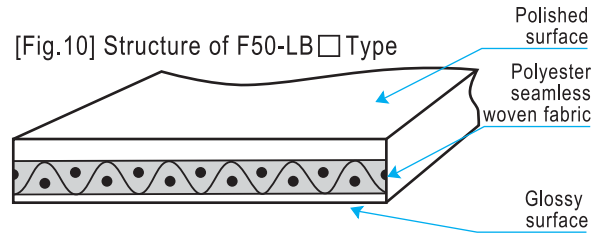
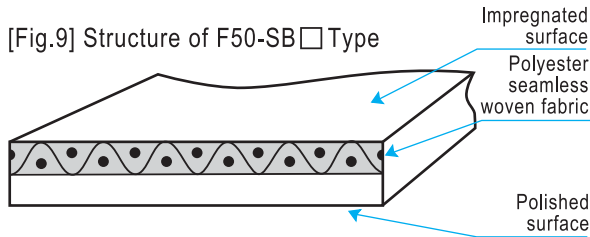

### ● Types and Properties

Item	F50-SBU	F50-LBU	F50-SBC2	F50-LBC	F50-SB	F50-LB	
1 Structure	Fig. 9	Fig. 10	Fig. 9	Fig. 10	Fig. 9	Fig. 10	
2 Available width (mm)	5 to 200	5 to 200	5 to 200	5 to 200	5 to 200	5 to 200	
3 Standard thickness (mm)	0.8	1.0	0.8	1.0	0.8	1.0	
4 Rubber material	Millable urethane	Millable urethane	Chloroprene rubber	Chloroprene rubber	Nitrile rubber	Nitrile rubber	
5 Surface figure	Impregnated surface	Polished surface	Impregnated surface	Polished surface	Impregnated surface	Polished surface	
6 Pulley surface figure	Polished surface	Glossy surface	Polished surface	Glossy surface	Polished surface	Glossy surface	
7 Weight	8	10	8	10	8	10	
8 Breaking strength (N/mm width)	24.5	24.5	24.5	24.5	24.5	24.5	
9 Standard elongation rate (%)	2.0	2.0	2.0	2.0	2.0	2.0	
10 Axial load at the standard elongation rate under stable conditions (N/mm width)	4.9	4.9	4.9	4.9	4.9	4.9	
11 Friction coefficient (against SUS)	Top surface	0.3 to 0.6	0.4 to 0.8	0.3 to 0.6	0.4 to 0.8	0.3 to 0.6	0.4 to 0.8
	Pulley surface	0.4 to 0.8	0.5 to 1.0	0.4 to 0.8	0.5 to 1.0	0.4 to 0.8	0.5 to 1.0
12 Minimum pulley diameter (mm)	φ 10	φ 15	φ 10	φ 15	φ 15	φ 20	
13 Operating temperature range	-20 to +60	-20 to +60	-20 to +80	-20 to +80	-20 to +80	-20 to +80	

# Standard Dimensional Tolerance

(1) Width (mm)

Width	Tolerance
5 or more and less than 11	±0.3
11 or more and less than 21	±0.5
21 or more and less than 101	± 1.0
101 or more	± 1.5

(2) Thickness (mm)

Thickness	Tolerance
0.8 or more and less than 1.0	±0.06
1.0 or more	±0.10

(3) F50-SB□ (Thickness: 0.8 mm) Type: List of Inner Peripheral Lengths (mm)

Inner peripheral length of less than 300				300 or more and less than 500			500 or more and less than 700		700 or more and less than 900	900 or more and less than 1100	1100 or more
Tolerance: ± 2 mm				Tolerance: ± 3 mm			Tolerance: ± 4 mm		Tolerance: ± 4.5 mm	Tolerance: ± 5.5 mm	Tolerance: ± 0.5 %
96.5	137.5	190.5	247.0	301.0	385.0	460.0	502.5	631.5	701.0	905.0	1108.0
99.0	138.0	192.5	249.0	303.5	388.0	463.5	504.5	639.5	706.0	914.5	1123.5
100.0	139.5	194.0	250.0	305.5	389.5	467.5	510.5	643.0	712.5	920.0	1144.0
102.0	141.5	198.0	251.5	307.0	393.5	470.5	518.5	654.0	713.0	942.5	1150.0
102.5	142.0	200.0	254.5	309.0	397.5	475.0	522.5	655.0	725.0	958.0	1150.5
104.5	143.5	201.5	256.0	313.0	402.0	482.5	529.0	660.5	735.0	967.5	1171.5
106.0	145.5	205.0	259.5	318.0	405.5	493.0	533.0	666.0	742.0	980.5	1181.5
107.5	149.0	206.0	260.0	319.0	410.0	495.0	537.5	670.0	748.0	987.5	1199.5
108.5	150.0	208.0	263.5	321.5	411.0		543.0	674.5	755.5	1004.0	1208.5
110.0	150.5	211.5	266.5	325.5	412.5		545.5	681.0	760.5	1008.0	1214.5
111.5	153.5	213.0	270.0	326.0	413.5		548.5	690.0	765.5	1022.5	1239.5
112.5	154.0	213.5	272.0	328.0	414.0		552.5	698.0	770.5	1029.0	1261.0
113.0	157.0	217.0	274.0	329.0	415.5		558.0		776.0	1031.0	1271.0
114.0	158.5	221.0	276.5	332.0	419.0		560.0		790.5	1033.5	1280.5
115.0	160.5	222.0	278.0	339.0	422.0		563.5		805.5	1048.5	1310.5
117.0	162.5	225.0	281.0	345.5	424.5		573.5		821.0	1058.0	1318.5
118.0	163.5	228.0	283.0	349.5	425.0		578.5		836.0	1068.0	1343.0
119.5	166.5	229.5	284.5	350.0	426.0		584.0		856.0	1074.0	1358.5
122.5	167.5	234.5	285.0	351.5	427.0		587.0		863.0	1075.0	1407.0
124.5	170.5	236.0	286.0	358.0	430.0		590.0		874.5	1079.0	1427.5
126.0	172.0	238.0	288.0	361.5	431.5		593.5		883.5	1081.5	1442.5
127.5	175.5	240.0	290.0	368.0	438.0		596.0			1088.5	1459.0
128.5	177.0	240.5	292.0	372.0	443.0		600.5			1097.0	1489.5
129.0	180.0	244.0	297.0	372.5	447.5		604.5				1505.5
130.5	181.0	245.5	299.0	374.0	451.0		607.5				1545.0
132.5	184.0	246.0	299.5	377.0	454.5		615.0				1560.0
134.5	189.0	246.5		381.5	457.0		620.0				

(4) F50-LB□ (Thickness: 1.0 mm) Type: List of Inner Peripheral Lengths (mm)

Inner peripheral length of less than 300				300 or more and less than 500			500 or more and less than 700		700 or more and less than 900	900 or more and less than 1100	1100 or more
Tolerance: ± 2 mm				Tolerance: ± 3 mm			Tolerance: ± 4 mm		Tolerance: ± 4.5 mm	Tolerance: ± 5.5 mm	Tolerance: ± 0.5 %
98.5	139.5	188.0	246.0	301.5	375.0	455.0	505.5	610.0	700.0	908.0	1101.0
102.0	140.5	191.5	248.0	302.0	379.0	456.5	507.5	617.5	703.5	918.0	1112.5
102.5	141.5	193.5	248.5	303.5	384.0	459.5	513.0	622.5	708.0	922.5	1127.5
105.0	142.0	195.0	249.0	306.0	387.0	462.0	522.0	633.5	715.0	945.0	1148.0
105.5	144.0	196.5	251.5	308.5	390.5	466.5	522.5	642.0	715.5	960.0	1154.0
107.5	145.0	200.5	253.0	309.0	393.0	470.0	525.5	645.5	727.5	971.0	1155.0
108.0	146.5	202.5	254.0	311.5	396.0	473.0	532.0	656.0	737.5	984.0	1176.0
110.0	148.0	204.0	256.5	315.0	400.0	477.0	537.0	658.0	744.0	990.0	1186.0
111.5	151.0	205.0	258.5	320.5	404.5	485.0	539.5	664.0	750.5	1006.0	1203.5
112.5	152.0	206.5	263.0	322.0	408.0	495.5	545.0	668.5	758.0	1010.5	1213.0
114.0	152.5	207.5	265.5	324.0	412.5	498.0	548.0	672.5	763.0	1026.0	1218.5
114.5	155.5	210.5	269.5	327.5	414.0		551.0	677.0	769.0	1030.0	1243.0
115.0	157.5	213.5	272.5	328.0	415.0		555.5	683.0	772.0	1033.5	1264.0
116.5	159.0	214.5	274.5	330.5	416.0		560.0	692.0	778.5	1037.5	1275.0
118.0	161.5	215.5	277.0	331.0	418.0		561.0		793.0	1052.5	1284.0
119.0	163.0	216.5	279.5	332.0	422.0		561.5		808.0	1062.0	1314.5
120.0	165.0	219.5	280.0	334.0	424.0		566.5		823.5	1070.5	1322.5
121.0	166.0	223.5	284.0	341.0	425.5		567.0		839.0	1076.0	1346.0
124.5	169.0	224.5	285.5	348.0	426.5		575.5		858.5	1078.0	1361.0
126.5	170.0	227.5	287.0	352.0	427.5		581.0		866.0	1082.0	1411.0
128.5	172.5	230.5	287.5	353.0	428.0		586.5		877.5	1084.5	1431.0
130.0	175.0	232.0	289.0	354.0	429.0		589.0		885.5	1093.0	1446.5
131.0	177.5	237.5	290.0	360.0	432.0		592.5				1463.0
131.5	179.5	238.5	292.5	364.5	434.0		596.0				1494.0
133.5	182.5	240.5	294.0	370.0	440.0		598.5				1510.0
135.0	184.0	242.5	299.0	373.0	446.0		603.0				1549.0
137.0	186.5	243.0		374.0	450.0		607.0				1564.0

\*If you wish to order a product with a size other than the standard, consult us.

\*SEB is built to order; the minimum order quantity is one lot. For details, contact our agencies or our sales representative.



# Conveyor and Medium-Load Power Transmission Belt

## F100 Series

Feature: This belt, which uses polyester seamless woven fabric as a tension member, is applied to conveyance and power transmission.

Use: OA equipment, ticket-vending machines, ATM, etc.

Cross Section

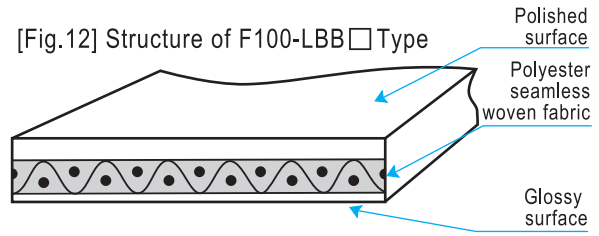
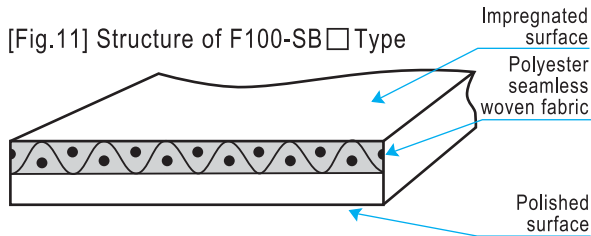

### ● Types and Properties

Item	F100-SBU	F100-LBU	F100-SBC2	F100-LBC	F100-SB	F100-LB	
1 Structure	Fig. 11	Fig. 12	Fig. 11	Fig. 12	Fig. 11	Fig. 12	
2 Available width (mm)	5 to 200	5 to 200	5 to 200	5 to 200	5 to 200	5 to 200	
3 Standard thickness (mm)	0.8	1.0	0.8	1.0	0.8	1.0	
4 Rubber material	Millable urethane	Millable urethane	Chloroprene rubber	Chloroprene rubber	Nitrile rubber	Nitrile rubber	
5 Surface figure	Impregnated surface	Polished surface	Impregnated surface	Polished surface	Impregnated surface	Polished surface	
6 Pulley surface figure	Polished surface	Glossy surface	Polished surface	Glossy surface	Polished surface	Glossy surface	
7 Weight	8	10	8	10	8	10	
8 Breaking strength (N/mm width)	39.2	39.2	39.2	39.2	39.2	39.2	
9 Standard elongation rate (%)	2.0	2.0	2.0	2.0	2.0	2.0	
10 Axial load at the standard elongation rate under stable conditions (N/mm width)	7.84	7.84	7.84	7.84	7.84	7.84	
11 Friction coefficient (against SUS)	Top surface	0.3 to 0.6	0.4 to 0.8	0.3 to 0.6	0.4 to 0.8	0.3 to 0.6	0.4 to 0.8
	Pulley surface	0.4 to 0.8	0.5 to 1.0	0.4 to 0.8	0.5 to 1.0	0.4 to 0.8	0.5 to 1.0
12 Minimum pulley diameter (mm)	φ 10	φ 15	φ 10	φ 15	φ 15	φ 20	
13 Operating temperature range	-20 to +60	-20 to +60	-20 to +80	-20 to +80	-20 to +80	-20 to +80	

# Standard Dimensional Tolerance

(1) Width (mm)

Width	Tolerance
5 or more and less than 11	±0.3
11 or more and less than 21	±0.5
21 or more and less than 101	±1.0
101 or more	±1.5

(2) Thickness (mm)

Thickness	Tolerance
0.8 or more and less than 1.0	±0.06
1.0 or more	±0.10

(3) F100-SB□ (Thickness: 0.8 mm) Type: List of Inner Peripheral Lengths (mm)

Inner peripheral length of less than 300				300 or more and less than 500			500 or more and less than 700		700 or more and less than 900	900 or more and less than 1100	1100 or more	
Tolerance: ± 2 mm				Tolerance: ± 3 mm			Tolerance: ± 4 mm		Tolerance: ± 4.5 mm	Tolerance: ± 5.5 mm	Tolerance: ± 0.5 %	
96.5	137.5	190.5	247.0	301.0	385.0	460.0	502.5	631.5	701.0	905.0	1108.0	
99.0	138.0	192.5	249.0	303.5	388.0	463.5	504.5	639.5	706.0	914.5	1123.5	
100.0	139.5	194.0	250.0	305.5	389.5	467.5	510.5	643.0	712.5	920.0	1144.0	
102.0	141.5	198.0	251.5	307.0	393.5	470.5	518.5	654.0	713.0	942.5	1150.0	
102.5	142.0	200.0	254.5	309.0	397.5	475.0	522.5	655.0	725.0	958.0	1150.5	
104.5	143.5	201.5	256.0	313.0	402.0	482.5	529.0	660.5	735.0	967.5	1171.5	
106.0	145.5	205.0	259.5	318.0	405.5	493.0	533.0	666.0	742.0	980.5	1181.5	
107.5	149.0	206.0	260.0	319.0	410.0	495.0	537.5	670.0	748.0	987.5	1199.5	
108.5	150.0	208.0	263.5	321.5	411.0		543.0	674.5	755.5	1004.0	1208.5	
110.0	150.5	211.5	266.5	325.5	412.5		545.5	681.0	760.5	1008.0	1214.5	
111.5	153.5	213.0	270.0	326.0	413.5		548.5	690.0	765.5	1022.5	1239.5	
112.5	154.0	213.5	272.0	328.0	414.0		552.5	698.0	770.5	1029.0	1261.0	
113.0	157.0	217.0	274.0	329.0	415.5		558.0		776.0	1031.0	1271.0	
114.0	158.5	221.0	276.5	332.0	419.0		560.0		790.5	1033.5	1280.5	
115.0	160.5	222.0	278.0	339.0	422.0		563.5		805.5	1048.5	1310.5	
117.0	162.5	225.0	281.0	345.5	424.5		573.5		821.0	1058.0	1318.5	
118.0	163.5	228.0	283.0	349.5	425.0		578.5		836.0	1068.0	1343.0	
119.5	166.5	229.5	284.5	350.0	426.0		584.0		856.0	1074.0	1358.5	
122.5	167.5	234.5	285.0	351.5	427.0		587.0		863.0	1075.0	1407.0	
124.5	170.5	236.0	286.0	358.0	430.0		590.0		874.5	1079.0	1427.5	
126.0	172.0	238.0	288.0	361.5	431.5		593.5		883.5	1081.5	1442.5	
127.5	175.5	240.0	290.0	368.0	438.0		596.0			1088.5	1459.0	
128.5	177.0	240.5	292.0	372.0	443.0		600.5			1097.0	1489.5	
129.0	180.0	244.0	297.0	372.5	447.5		604.5				1505.5	
130.5	181.0	245.5	299.0	374.0	451.0		607.5				1545.0	
132.5	184.0	246.0	299.5	377.0	454.5		615.0				1560.0	
134.5	189.0	246.5		381.5	457.0		620.0					

(4) F100-LB□ (Thickness: 1.0 mm) Type: List of Inner Peripheral Lengths (mm)

Inner peripheral length of less than 300				300 or more and less than 500			500 or more and less than 700		700 or more and less than 900	900 or more and less than 1100	1100 or more	
Tolerance: ± 2 mm				Tolerance: ± 3 mm			Tolerance: ± 4 mm		Tolerance: ± 4.5 mm	Tolerance: ± 5.5 mm	Tolerance: ± 0.5 %	
98.5	139.5	188.0	246.0	301.5	375.0	455.0	505.5	610.0	700.0	908.0	1101.0	
102.0	140.5	191.5	248.0	302.0	379.0	456.5	507.5	617.5	703.5	918.0	1112.5	
102.5	141.5	193.5	248.5	303.5	384.0	459.5	513.0	622.5	708.0	922.5	1127.5	
105.0	142.0	195.0	249.0	306.0	387.0	462.0	522.0	633.5	715.0	945.0	1148.0	
105.5	144.0	196.5	251.5	308.5	390.5	466.5	522.5	642.0	715.5	960.0	1154.0	
107.5	145.0	200.5	253.0	309.0	393.0	470.0	525.5	645.5	727.5	971.0	1155.0	
108.0	146.5	202.5	254.0	311.5	396.0	473.0	532.0	656.0	737.5	984.0	1176.0	
110.0	148.0	204.0	256.5	315.0	400.0	477.0	537.0	658.0	744.0	990.0	1186.0	
111.5	151.0	205.0	258.5	320.5	404.5	485.0	539.5	664.0	750.5	1006.0	1203.5	
112.5	152.0	206.5	263.0	322.0	408.0	495.5	545.0	668.5	758.0	1010.5	1213.0	
114.0	152.5	207.5	265.5	324.0	412.5	498.0	548.0	672.5	763.0	1026.0	1218.5	
114.5	155.5	210.5	269.5	327.5	414.0		551.0	677.0	769.0	1030.0	1243.0	
115.0	157.5	213.5	272.5	328.0	415.0		555.5	683.0	772.0	1033.5	1264.0	
116.5	159.0	214.5	274.5	330.5	416.0		560.0	692.0	778.5	1037.5	1275.0	
118.0	161.5	215.5	277.0	331.0	418.0		561.0		793.0	1052.5	1284.0	
119.0	163.0	216.5	279.5	332.0	422.0		561.5		808.0	1062.0	1314.5	
120.0	165.0	219.5	280.0	334.0	424.0		566.5		823.5	1070.5	1322.5	
121.0	166.0	223.5	284.0	341.0	425.5		567.0		839.0	1076.0	1346.0	
124.5	169.0	224.5	285.5	348.0	426.5		575.5		858.5	1078.0	1361.0	
126.5	170.0	227.5	287.0	352.0	427.5		581.0		866.0	1082.0	1411.0	
128.5	172.5	230.5	287.5	353.0	428.0		586.5		877.5	1084.5	1431.0	
130.0	175.0	232.0	289.0	354.0	429.0		589.0		885.5	1093.0	1446.5	
131.0	177.5	237.5	290.0	360.0	432.0		592.5				1463.0	
131.5	179.5	238.5	292.5	364.5	434.0		596.0				1494.0	
133.5	182.5	240.5	294.0	370.0	440.0		598.5				1510.0	
135.0	184.0	242.5	299.0	373.0	446.0		603.0				1549.0	
137.0	186.5	243.0		374.0	450.0		607.0				1564.0	

\*If you wish to order a product with a size other than the standard, consult us.

\*SEB is built to order; the minimum order quantity is one lot. For details, contact our agencies or our sales representative.

# Medium-Load Power Transmission Belt

## XA • A Series

Feature: This belt, which uses a cord as a tension member, is applied to medium-load power transmission.

Use: Low-torque, high-speed power transmission, draw texturing machines, feeder belts, etc.

Cross Section

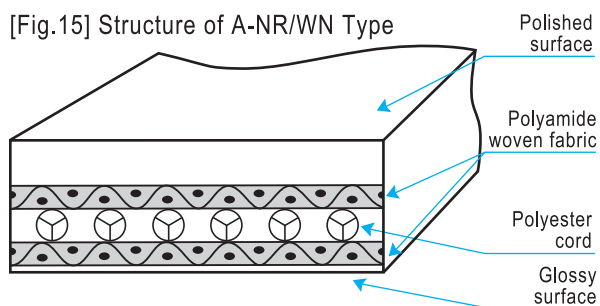
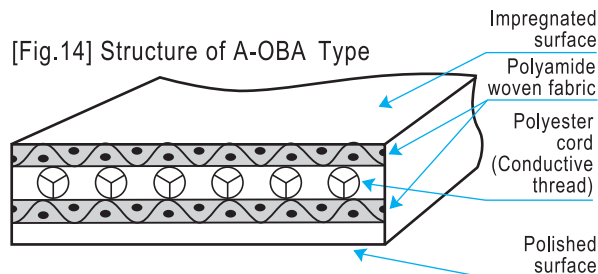
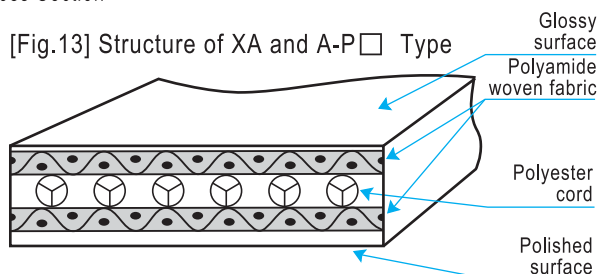

### ● Types and Properties

Item	XA-PB	A-PB	A-OBA	A-PC	A-NR	A-WN	
1 Structure	Fig. 13	Fig. 13	Fig. 14	Fig. 13	Fig. 15	Fig. 15	
2 Available width (mm) ※1	5 to 400	5 to 400	5 to 400	5 to 400	7 to 400	7 to 400	
3 Standard thickness (mm) ※2	1.1	1.2	1.2	1.2	3.0 to 8.0	3.0 to 8.0	
4 Rubber material	Nitrile rubber	Nitrile rubber	Nitrile rubber	Chloroprene rubber	Blue natural rubber	White natural rubber	
5 Surface figure	Glossy surface	Glossy surface	Impregnated surface	Glossy surface	Polished surface	Polished surface	
6 Pulley surface figure	Polished surface	Polished surface	Polished surface	Polished surface	Glossy surface	Glossy surface	
7 Weight	12	14	14	14	102	102	
8 Breaking strength (N/mm width)	29.4	58.8	58.8	58.8	58.8	58.8	
9 Standard elongation rate (%)	1.0	1.0	1.0	1.0	0.5	0.5	
10 Axial load at the standard elongation rate under stable conditions (N/mm width)	7.35	14.7	14.7	14.7	7.35	7.35	
11 Friction coefficient (against SUS)	Top surface	0.2 to 0.4	0.2 to 0.4	0.1 to 0.3	0.2 to 0.4	1.5 (Against cardboard)	2.0 (Against cardboard)
	Pulley surface	0.4 to 0.8	0.4 to 0.8	0.4 to 0.8	0.4 to 0.8		
12 Minimum pulley diameter (mm)	φ 15	φ 15	φ 15	φ 15	φ 80	φ 80	
13 Operating temperature range	-20 to +80	-20 to +80	-20 to +80	-20 to +80	-20 to +60	-20 to +60	

※1 The maximum width of the above types (except for A-NR and A-WN) is 1/5 of the inner peripheral length.  
 ※2 For A-NR and A-WN, specify thickness. (We provide you a belt with a length on a 1 mm basis)

# Standard Dimensional Tolerance

(1) Width (mm)

Width	Tolerance
5 or more and less than 11	±0.3
11 or more and less than 21	±0.5
21 or more and less than 101	±1.0
101 or more	±1.5

(2) Thickness (mm)

Thickness	Tolerance
1.0 or more	±0.10

Belt type	Tolerance
A-WN A-NR	±0.50

(3) XA/A Type: List of Inner Peripheral Lengths (mm)

Inner peripheral length of less than 300			300 or more and less than 600			600 or more and less than 800	800 or more and less than 1000	1000 or more		
Tolerance: ± 2 mm			Tolerance: ± 3 mm			Tolerance: ± 4 mm	Tolerance: ± 5 mm	Tolerance: ± 0.5 %		
128.0	181.0	250.0	300.0	396.0	500.0	600.0	800.0	1000.0	1300.0	2160.0
128.5	184.0	251.0	302.0	400.0	501.0	605.0	815.0	1008.0	1308.0	2181.0
129.0	189.0	254.0	305.0	404.0	508.0	610.0	830.0	1016.0	1338.0	2185.0
131.0	191.0	255.0	306.0	407.0	516.0	617.0	850.0	1021.0	1350.0	2190.0
133.0	192.0	260.0	307.0	409.0	520.0	626.0	857.0	1023.0	1396.0	2200.0
135.0	194.0	263.0	312.0	410.0	525.0	635.0	870.0	1026.0	1415.0	2230.0
137.0	198.0	266.0	316.0	411.0	529.0	638.0	876.0	1041.0	1430.0	2248.0
138.0	200.0	269.0	317.0	414.0	534.0	648.0	900.0	1050.0	1450.0	2270.0
140.0	202.0	272.0	320.0	417.0	539.0	650.0	908.0	1060.0	1478.0	2300.0
141.0	204.0	274.0	324.0	420.0	542.0	656.0	913.0	1066.0	1500.0	2360.0
143.0	205.0	276.0	326.0	421.0	545.0	660.0	935.0	1067.0	1535.0	2500.0
144.0	208.0	278.0	327.0	422.0	550.0	665.0	950.0	1071.0	1550.0	2570.0
145.0	210.0	281.0	328.0	423.0	553.0	670.0	960.0	1073.0	1590.0	2750.0
149.0	212.0	282.0	331.0	426.0	555.0	676.0	973.0	1080.0	1600.0	2808.0
149.5	214.0	283.0	338.0	427.0	560.0	685.0	980.0	1093.0	1620.0	2819.0
150.0	216.0	284.0	344.0	430.0	570.0	692.0	995.0	1100.0	1645.0	2890.0
153.0	220.0	285.0	347.0	435.0	575.0	695.0		1115.0	1653.0	3336.0
154.0	221.0	287.0	348.0	441.0	580.0	700.0		1135.0	1660.0	4525.0
157.0	224.0	289.0	350.0	445.0	583.0	707.0		1142.0	1700.0	
159.0	227.0	291.0	356.0	450.0	586.0	708.0		1145.0	1708.0	
160.0	230.0	295.0	360.0	452.0	589.0	720.0		1165.0	1800.0	
162.0	235.0	296.0	366.0	456.0	592.0	729.0		1175.0	1835.0	
164.0	236.0	298.0	369.0	457.0	597.0	736.0		1190.0	1850.0	
166.0	238.0		370.0	461.0		743.0		1200.0	1890.0	
167.0	239.0		374.0	465.0		750.0		1207.0	1965.0	
170.0	240.0		380.0	468.0		755.0		1230.0	1970.0	
172.0	243.0		382.0	472.0		760.0		1234.0	2070.0	
175.0	245.0		386.0	480.0		764.0		1250.0	2100.0	
177.0	247.0		388.0	489.0		770.0		1261.0	2118.0	
180.0	248.0		392.0	493.0		785.0		1270.0	2150.0	

\* If you wish to order a product with a size other than the standard, consult us.

\* SEB is built to order; the minimum order quantity is one lot. When ordering the belt with length other than the above, consult us.

For details, contact our agencies or our sales representative.

\* We can provide you A-NR/A-WN with a length from 400 – 1970 mm.

# High-Load Power Transmission Belt

## B·D·GS Series

Feature: This belt, which uses a cord as a tension member, is mainly applied to high-load power transmission.

Use: Grinding machines, internal grinders, industrial vacuum cleaners, etc.

Cross Section

[Fig.16] Structure of B/D-PB Type

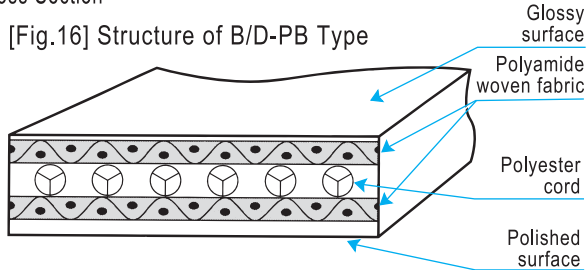

[Fig.17] Structure of GS-OC Type

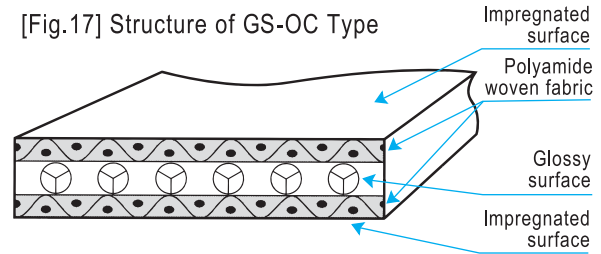

### ● Types and Properties

Item	B-PB	D-PB	GS-OC	
1 Structure	Fig. 16	Fig. 16	Fig. 17	
2 Available width (mm) ※	5 to 400	5 to 400	5 to 400	
3 Standard thickness (mm)	1.4	1.7	0.75	
4 Rubber material	Nitrile rubber	Nitrile rubber	Chloroprene rubber	
5 Surface figure	Glossy surface	Glossy surface	Impregnated surface	
6 Pulley surface figure	Polished surface	Polished surface	Impregnated surface	
7 Weight	16	20	10	
8 Breaking strength (N/mm width)	118	235	167	
9 Standard elongation rate (%)	1.0	1.0	0.3	
10 Axial load at the standard elongation rate under stable conditions (N/mm width)	29.4	58.8	14.7	
11 Friction coefficient (against SUS)	Top surface	0.2 to 0.4	0.2 to 0.4	0.1 to 0.3
	Pulley surface	0.4 to 0.8	0.4 to 0.8	0.1 to 0.3
12 Minimum pulley diameter (mm)	φ25	φ35	φ20	
13 Operating temperature range	-20 to +80	-20 to +80	-20 to +80	

※The maximum width is 1/5 of the inner peripheral length.

# Standard Dimensional Tolerance

(1) Width (mm)

Width	Tolerance
5 or more and less than 11	±0.3
11 or more and less than 21	±0.5
21 or more and less than 101	±1.0
101 or more	±1.5

(2) Thickness of B/D Type (mm)

Thickness	Tolerance
0.8 or more and less than 1.0	±0.06
1.0 or more	±0.10

Belt type	Tolerance
GS-OC	±0.10
GL-OC	±0.15

(3) B/D Type: List of Inner Peripheral Lengths (mm)

Inner peripheral length of less than 300			300 or more and less than 600			600 or more and less than 800	800 or more and less than 1000	1000 or more		
Tolerance: ± 2 mm			Tolerance: ± 3 mm			Tolerance: ± 4 mm	Tolerance: ± 5 mm	Tolerance: ± 0.5 %		
128.0	181.0	250.0	300.0	396.0	500.0	600.0	800.0	1000.0	1300.0	2160.0
128.5	184.0	251.0	302.0	400.0	501.0	605.0	815.0	1008.0	1308.0	2181.0
129.0	189.0	254.0	305.0	404.0	508.0	610.0	830.0	1016.0	1338.0	2185.0
131.0	191.0	255.0	306.0	407.0	516.0	617.0	850.0	1021.0	1350.0	2190.0
133.0	192.0	260.0	307.0	409.0	520.0	626.0	857.0	1023.0	1396.0	2200.0
135.0	194.0	263.0	312.0	410.0	525.0	635.0	870.0	1026.0	1415.0	2230.0
137.0	198.0	266.0	316.0	411.0	529.0	638.0	876.0	1041.0	1430.0	2248.0
138.0	200.0	269.0	317.0	414.0	534.0	648.0	900.0	1050.0	1450.0	2270.0
140.0	202.0	272.0	320.0	417.0	539.0	650.0	908.0	1060.0	1478.0	2300.0
141.0	204.0	274.0	324.0	420.0	542.0	656.0	913.0	1066.0	1500.0	2360.0
143.0	205.0	276.0	326.0	421.0	545.0	660.0	935.0	1067.0	1535.0	2500.0
144.0	208.0	278.0	327.0	422.0	550.0	665.0	950.0	1071.0	1550.0	2570.0
145.0	210.0	281.0	328.0	423.0	553.0	670.0	960.0	1073.0	1590.0	2750.0
149.0	212.0	282.0	331.0	426.0	555.0	676.0	973.0	1080.0	1600.0	2808.0
149.5	214.0	283.0	338.0	427.0	560.0	685.0	980.0	1093.0	1620.0	2819.0
150.0	216.0	284.0	344.0	430.0	570.0	692.0	995.0	1100.0	1645.0	2890.0
153.0	220.0	285.0	347.0	435.0	575.0	695.0		1115.0	1653.0	3336.0
154.0	221.0	287.0	348.0	441.0	580.0	700.0		1135.0	1660.0	4525.0
157.0	224.0	289.0	350.0	445.0	583.0	707.0		1142.0	1700.0	
159.0	227.0	291.0	356.0	450.0	586.0	708.0		1145.0	1708.0	
160.0	230.0	295.0	360.0	452.0	589.0	720.0		1165.0	1800.0	
162.0	235.0	296.0	366.0	456.0	592.0	729.0		1175.0	1835.0	
164.0	236.0	298.0	369.0	457.0	597.0	736.0		1190.0	1850.0	
166.0	238.0		370.0	461.0		743.0		1200.0	1890.0	
167.0	239.0		374.0	465.0		750.0		1207.0	1965.0	
170.0	240.0		380.0	468.0		755.0		1230.0	1970.0	
172.0	243.0		382.0	472.0		760.0		1234.0	2070.0	
175.0	245.0		386.0	480.0		764.0		1250.0	2100.0	
177.0	247.0		388.0	489.0		770.0		1261.0	2118.0	
180.0	248.0		392.0	493.0		785.0		1270.0	2150.0	

(4) GS Type: List of Inner Peripheral Lengths (mm)

Inner peripheral length of less than 300				300 or more and less than 600				600 or more and less than 800	800 or more and less than 1000	1000 or more		
Tolerance: ± 2 mm				Tolerance: ± 3 mm				Tolerance: ± 4 mm	Tolerance: ± 5 mm	Tolerance: ± 0.5 %		
147.0	186.0	232.0	274.0	301.0	363.0	428.0	521.0	603.0	714.0	808.0	1006.0	1185.0
150.0	191.0	237.0	276.0	302.0	370.0	429.0	525.0	607.0	715.0	823.0	1011.0	1202.0
151.0	192.0	238.0	278.0	303.0	373.0	432.0	531.0	610.0	727.0	839.0	1025.0	1212.0
152.0	194.0	240.0	280.0	306.0	375.0	434.0	535.0	617.0	737.0	858.0	1031.0	1217.0
155.0	196.0	242.0	283.0	307.0	378.0	440.0	539.0	622.0	743.0	865.0	1033.0	1242.0
156.0	200.0	243.0	285.0	309.0	383.0	445.0	540.0	634.0	750.0	877.0	1036.0	1263.0
159.0	202.0	246.0	286.0	311.0	387.0	450.0	545.0	642.0	758.0	885.0	1051.0	1274.0
160.0	203.0	247.0	287.0	315.0	390.0	453.0	548.0	642.0	758.0	885.0	1061.0	1283.0
162.0	206.0	247.5	288.0	320.0	392.0	456.0	551.0	645.0	763.0	908.0	1070.0	1313.0
164.0	207.0	249.0	290.0	321.0	396.0	459.0	555.0	656.0	768.0	917.0	1074.0	1321.0
165.0	210.0	251.0	292.0	323.0	400.0	462.0	559.0	657.0	772.0	922.0	1077.0	1346.0
168.0	213.0	252.0	294.0	328.0	404.0	466.0	561.0	663.0	778.0	945.0	1081.0	1361.0
169.0	214.0	253.0	299.0	330.0	408.0	470.0	566.0	668.0	793.0	960.0	1084.0	1410.0
172.0	216.0	256.0		331.0	412.0	473.0	575.0	672.0		970.0	1091.0	1430.0
174.0	219.0	258.0		332.0	413.0	477.0	581.0	672.0		970.0	1100.0	1445.0
177.0	223.0	262.0		341.0	415.0	484.0	586.0	677.0		983.0	1111.0	1462.0
179.0	224.0	265.0		347.0	417.0	495.0	589.0	684.0		990.0	1126.0	1493.0
182.0	227.0	269.0		351.0	421.0	497.0	592.0	692.0			1147.0	1509.0
183.0	230.0	272.0		352.0	424.0	505.0	596.0	700.0			1153.0	1548.0
				353.0	425.0	507.0	598.0	704.0			1156.0	1563.0
				360.0	427.0	512.0		708.0			1174.0	

\*If you wish to order a product with a size other than the standard, consult us.

\*SEB is built to order; the minimum order quantity is one lot. For details, contact our agencies or our sales representative.

# High-Temperature Conveyor and Low-Load Power Transmission Belt

## H50 Series

Feature: This belt, which uses highly heat-resistant rubber and seamless woven fabric, is applied to heat-resistant conveyance and low-load power transmission.

Use: Conveying silver-halide sensitized paper, high-temperature pinching conveyance, etc.

Cross Section

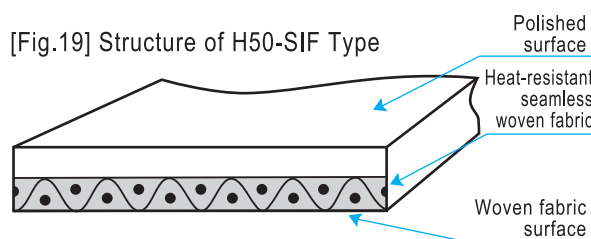
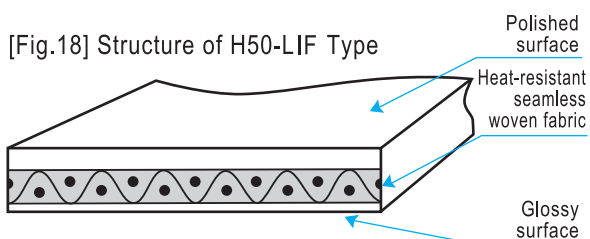

### ● Types and Properties

Item	H50-LIF	H50-SIF
1 Structure	Fig. 18	Fig. 19
2 Available width (mm)	5 to 200	5 to 200
3 Standard thickness (mm)	1.0	0.7
4 Rubber material	White fluorine-containing rubber	White fluorine-containing rubber
5 Surface figure	Polished surface	Polished surface
6 Pulley surface figure	Glossy surface	Woven fabric surface
7 Weight	19	11
8 Breaking strength (N/mm width)	24.5	16.7
9 Standard elongation rate (%)	2.0	2.0
10 Axial load at the standard elongation rate under stable conditions (N/mm width)	4.9	4.9
11 Friction coefficient	Top surface	0.4 to 0.8
	Pulley surface	0.5 to 1.0
12 Minimum pulley diameter (mm)	φ 15	φ 15
13 Operating temperature range	-20 to +200	-20 to +200

# Standard Dimensional Tolerance

(1) Width (mm)

Width	Tolerance
5 or more and less than 11	±0.3
11 or more and less than 21	±0.5
21 or more and less than 101	±1.0
101 or more	±1.5

(2) Thickness (mm)

Thickness	Tolerance
0.8 or more and less than 1.0	±0.06
1.0 or more	±0.10

(3) H50 Type: List of Inner Peripheral Lengths (mm)

350 or more and less than 500		500 or more and less than 700		700 or more and less than 900	900 or more and less than 1100	1100 or more
Tolerance: ± 3 mm		Tolerance: ± 4 mm		Tolerance: ± 4.5 mm	Tolerance: ± 5.5 mm	Tolerance: ± 0.5 %
352.0	440.0	505.5	642.0	700.0	908.0	1101.0
353.0	446.0	507.5	645.5	703.5	918.0	1112.5
360.0	450.0	513.0	656.0	708.0	922.5	1127.5
364.5	455.0	522.0	658.0	715.0	945.0	1148.0
370.0	459.5	525.5	664.0	715.5	960.0	1155.0
374.0	466.5	532.0	668.5	727.5	971.0	1176.0
375.0	470.0	537.0	672.5	737.5	983.0	1186.0
379.0	473.0	539.5	677.0	744.0	990.0	1203.5
384.0	477.0	545.0	683.0	750.5	1006.0	1213.0
387.0	485.0	548.0	692.0	758.0	1010.5	1218.5
390.5	495.5	551.0		763.0	1026.0	1243.0
393.0	498.0	555.5		769.0	1037.5	1264.0
396.0		560.0		772.0	1052.5	1275.0
400.0		567.0		778.5	1062.0	1284.0
404.5		575.5		793.0	1076.0	1314.5
408.0		581.0		808.0	1082.0	1322.5
412.5		586.5		823.5	1084.5	1346.0
414.0		589.0		839.0	1093.0	1361.0
415.0		592.5		858.5		1411.0
416.0		596.0		877.5		1431.0
418.0		598.5		885.5		1446.5
422.0		603.0				1463.0
424.0		607.0				1494.0
426.5		610.0				1510.0
427.5		617.5				1549.0
432.0		622.5				1564.0
434.0		633.5				

\* Each inner peripheral length of H50-SIF Type shown in the list above is obtained when the impregnated surface is placed on the pulley side.

For the inner peripheral length obtained when the impregnated surface is placed in the opposite way, contact us.

\* If you wish to order a product with a size other than the standard, consult us.

\* SEB is built to order; the minimum order quantity is one lot. For details, contact our agencies or our sales representative.



# Selecting Belt

## 1 Selecting Conditions

When selecting a belt, it is necessary to pay attention to not only the performance and characteristics of the belt but also the use conditions and environment of the machine. Therefore, refer to the following items.

- 1.1 Use Conditions**
1. Types of motors
  2. Operating condition (Load fluctuation)
  3. Load inertia
  4. Accelerating torque
  5. Number of revolutions (Speed)
  6. Conveyance condition and method
  7. Pulley diameter
  8. Speed ratio
  9. Center distance

- 1.3 Belt Performance**
1. Standard elongation rate
  2. Tension under stable conditions
  3. Rubber material
  4. Tension member structure
  5. Surface friction coefficient
  6. Pitch line position
  7. Minimum pulley diameter
  8. Antistatic performance
  9. Mass

- 1.2 Use Environment**
1. Atmosphere (Oil, water, dust and ozone)
  2. Ambient temperature (during operation and stop)
  3. Ray (Ultraviolet rays)

- 1.4 Installation Conditions**
1. Tension adjustment (Adjusting/fixing axis)
  2. Pulley shape (Width and crown height)
  3. Selecting belt top/bottom surfaces

## 2 Selecting Procedures

Fully understand the purpose and conditions of the belt use for selecting the belt type. Then select the belt width according to transmission/conveyance capacity and calculate the required elongation rate.

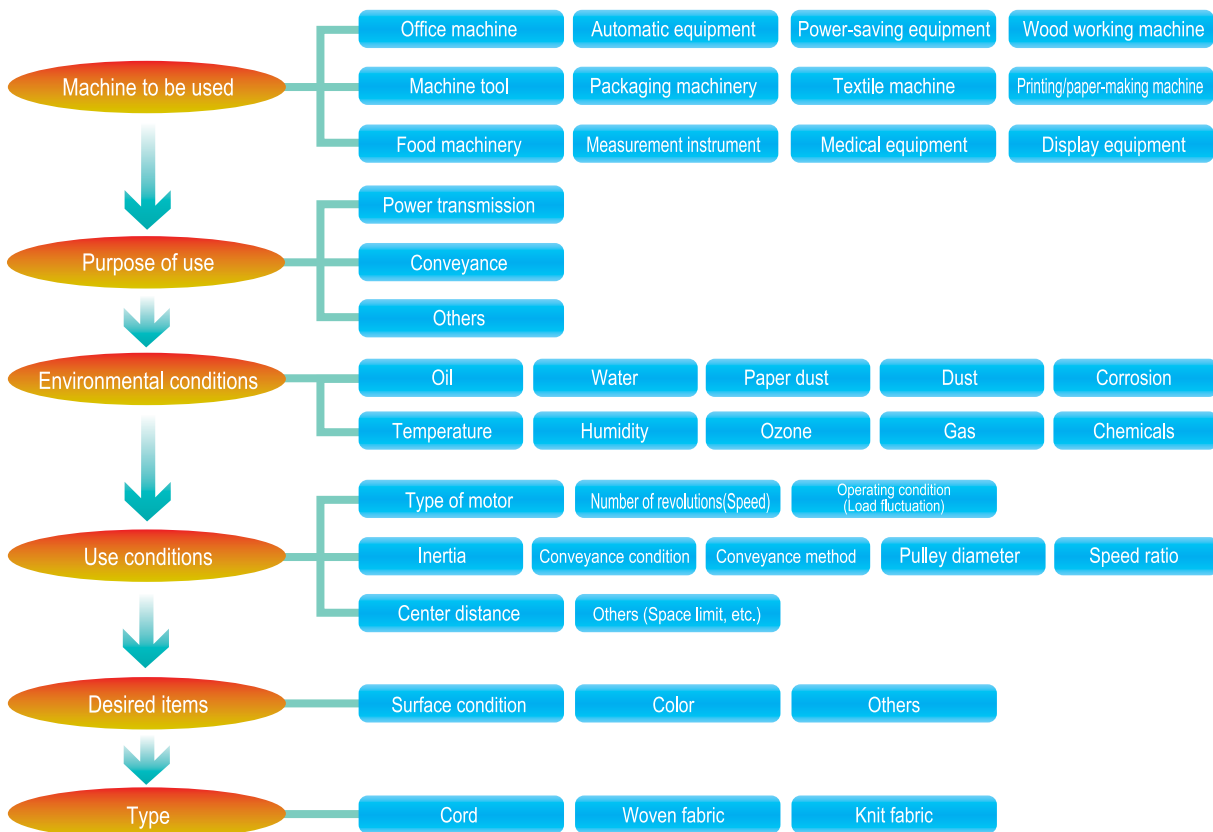

### 3 Selecting Type

When selecting the belt type, examine the use, use environment and the difficulty level of maintenance/inspection for the machine using the belt. After fully understanding the features of each belt type, select the most suitable one.

Tension member structure	Seamless knit fabric (Polyester, etc.)	Seamless woven fabric (Polyester, etc.)		Cord (Polyester, etc.)
Major types	N-SMV1/V2, N-LBU, etc.	G15, G30, etc.	F50, F100, etc.	XA, A, B, D, etc.
Major application	Conveyance	Low-load power transmission and conveyance	Medium-load power transmission and conveyance	Power transmission
Strength	High			Low
Stretch properties	High			Low

### 4 Selecting Structure

Code	Main Features and Application
Code starting with the letter "S" (SB, SBC, SBU, etc.)	Pinching a paper sheet between belts for conveyance
Code starting with the letter "L" (LB, LBC, LBU, etc.)	Pinching a hard card between belts for conveyance
Code starting with the letter "P" (PB, PC, etc.)	High-precision power transmission
Code ending with the letter "A" (OBA, etc.)	Used for high-precision power transmission requiring antistatic performance
PSS	Used when both surfaces of the belt are required to be driven
OC	Used for the extremely low-stretch belt that uses glass fiber cord as a tension member
NR, WN	Used when high friction coefficient is required on the back surface

Determine the belt type and structure by examining the applications and the rubber properties mentioned in P 2 and 3.

# Design Materials

Transmitted Power Correction Factor Depending on Overload Fluctuation

Motor overload fluctuation		149 % or less			199 % or less			249 % or less			250 % or less		
Environmental conditions		A	B	C	A	B	C	A	B	C	A	B	C
Operating conditions	Smooth	1.2	1.4	1.8	1.4	1.7	2.1	1.6	1.9	2.4	1.8	2.1	2.7
	Nearly smooth	1.3	1.5	1.9	1.5	1.8	2.2	1.7	2.0	2.5	1.9	2.2	2.8
	High impact	1.4	1.7	2.1	1.6	1.9	2.4	1.8	2.1	2.7	2.0	2.4	3.0
	Low impact	1.5	1.8	2.2	1.7	2.0	2.5	1.9	2.2	2.8	2.1	2.5	3.1
	Medium impact	1.6	1.9	2.4	1.8	2.1	2.7	2.0	2.4	3.0	2.2	2.6	3.3

Environmental conditions	A	Normal
	B	Slightly poor
	C	Poor (Attachment of large quantities of oil, etc.)

## ● Types of Motors

- 1. Maximum output: Rated output of 149 % or less**  
AC wound motors, DC motors, etc.
- 2. Maximum output: Rated output of 150 – 199 %**  
AC wound motors, normal torque motors, etc.
- 3. Maximum output: Rated output of 200 - 249 %**  
AC wound motors, DC compound-wound motors, normal torque synchronous motors, etc.
- 4. Maximum output: Rated output of 250 % or more**  
DC series-wound motors, high torque synchronous motors, AC single-phase motors, line shaft motors, etc.

## ● Operating Conditions for Machines to Be Used

- 1. Extremely smooth power transmission**  
Liquid agitators, blowers, small machine tools, low-load conveyors, etc.
- 2. Nearly smooth power transmission**  
Machine tools, line shaft motors, pumps, washing machines, viscous material mixers, etc.
- 3. Power transmission with low impact**  
Compressors, generators, wood working machines, elevators, rubber calenders, etc.
- 4. Power transmission with medium impact**  
Centrifugal machines, bucket elevators, pulverizers, saw mills, wood working machine, etc.
- 5. Power transmission with high impact**  
Crusher mills, piston compressors, pumps, extruders, etc.

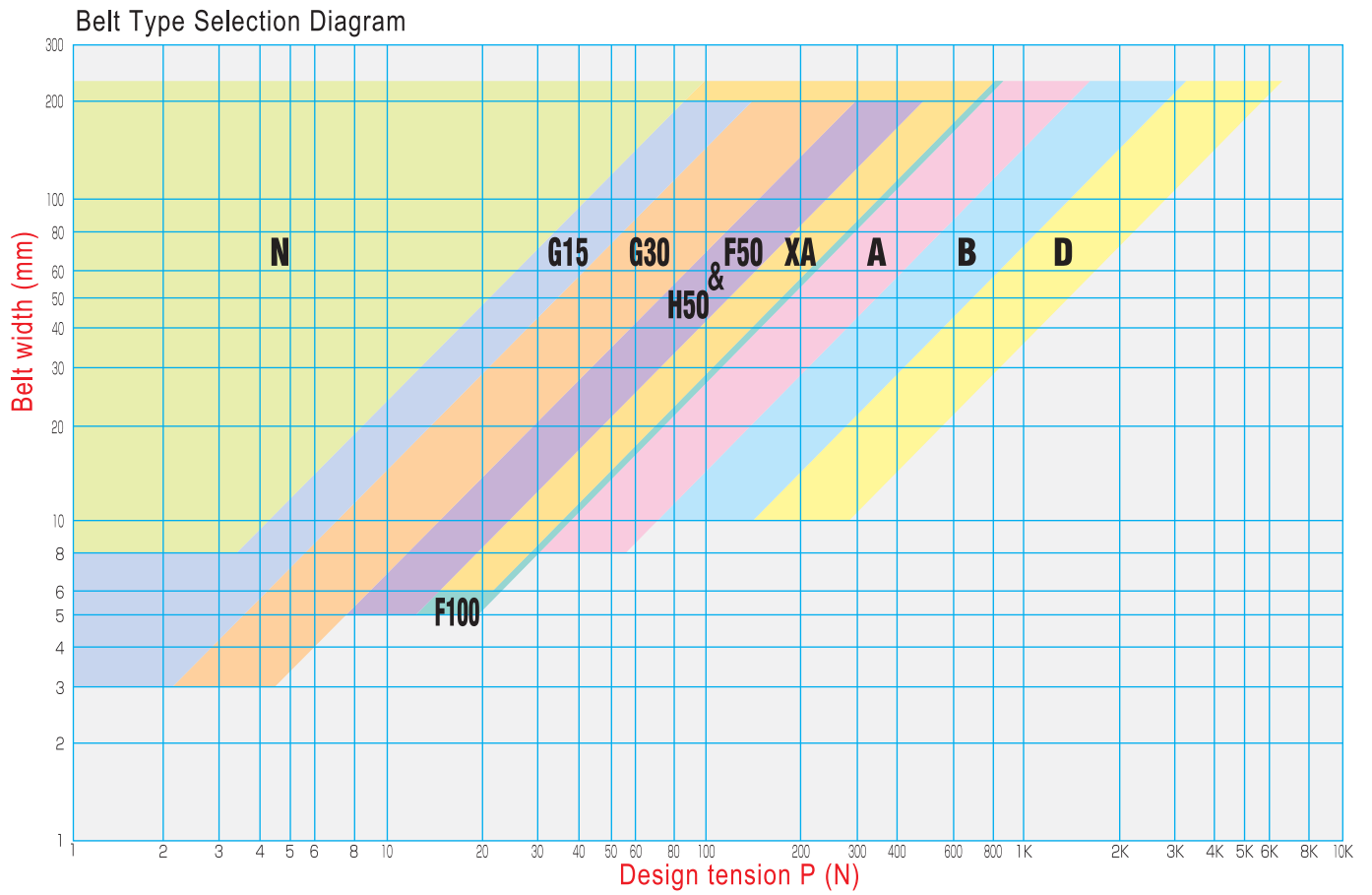

### Traction coefficient ( $\lambda$ )

Angle of contact with pulley ( ° )	70	80	90	100	110	120	130
Traction coefficient ( $\lambda$ )	0.2396	0.2722	0.3042	0.3355	0.3662	0.3960	0.4250
Angle of contact with pulley ( ° )	140	150	160	170	180	190	200
Traction coefficient ( $\lambda$ )	0.4532	0.4805	0.5069	0.5323	0.5569	0.5805	0.6032
Angle of contact with pulley ( ° )	210	220	230	240	250	260	270
Traction coefficient ( $\lambda$ )	0.6249	0.6457	0.6656	0.6846	0.7027	0.7200	0.7364

# Calculation for Selecting Belt

## Design Procedure 1

### Calculating the effective tension applied to the belt

Calculating the effective tension from the transmitted power

(1) Calculate the belt speed (V).

$$V \text{ (m/s)} \quad V = \frac{\pi \times D \times n}{60000}$$

$\pi$  : Circumference ratio  
 $D$  : Drive pulley diameter (mm)  
 $n$  : Number of revolutions of the drive pulley (r/min)

(2) Calculate the effective tension (Te), where the transmitted power is kW.

$$Te \text{ (N)} \quad Te = \frac{1000 \times P_m}{V}$$

$P_m$  : Transmitted power (kW)

(2') Calculate the effective tension (Te), where the transmitted power is W.

$$Te \text{ (N)} \quad Te = \frac{P_m'}{V}$$

$P_m'$  : Transmitted power (kW)

Calculating the effective tension from the transmission torque (Tr)

(1) When the unit of torque is N·m

$$Te \text{ (N)} \quad Te = \frac{2000 \times Tr}{D}$$

$Tr$  : Torque (N·m)  
 $D$  : Pulley outer diameter (mm)

(2) When the unit of torque is N·mm

$$Te \text{ (N)} \quad Te = \frac{2 \times Tr'}{D}$$

$Tr'$  : Torque (N·mm)  
 $D$  : Pulley outer diameter (mm)

Calculating the torque (Tr) caused by inertia

(1) Calculate the torque (Tr) caused by the moment of inertia (J).

$$Tr \text{ (N·m)} \quad Tr = \frac{J \times (n_1 - n_2)}{9.55 \times t}$$

$J$  : Moment of inertia (kgm<sup>2</sup>)  
 $n_1 - n_2$  : Difference in number of revolutions (r/min)  
 $t$  : Acceleration/deceleration time (S)

(1') Calculate the torque (Tr) caused by GD<sup>2</sup>.

$$Tr \text{ (N·m)} \quad Tr = \frac{GD^2 \times (n_1 - n_2)}{38.2 \times t}$$

$GD^2$  : Flywheel effect (kgf·m<sup>2</sup>)  
 $n_1 - n_2$  : Difference in number of revolutions (r/min)  
 $t$  : Acceleration/deceleration time (S)

(2) Calculate the effective tension (Te) caused by the weight of the conveyed object, during acceleration/deceleration.

$$Te \text{ (N)} \quad Te = m \times \alpha$$

$m$  : Mass (kg)  
 $\alpha$  : Acceleration/deceleration speed (m/s<sup>2</sup>)

## Design Procedure 2

### Calculating the design tension

Obtain the transmitted power correction factor (K1) from the table at Page 24. Then calculate the design tension (P).

$$P \text{ (N)} \quad P = Te \times K_1$$

## Design Procedure 3

### Selecting the belt type

Select the belt type from the Belt Type Selection Diagram (P. 25)

## Design Procedure 4

### Calculating the traction coefficient (λ)

Calculate the contact angle  $\theta$  (rad) of the belt on the pulley, from the pulley layout. Select the appropriate pulley diameter from the speed ratio, the pulley limit diameter, etc. and calculate the contact angle  $\theta$  (rad) of the belt on the pulley.

Calculate the contact angle  $\theta$  (rad).

$$\theta \text{ (rad)} = \pi - 2 \sin^{-1} \left[ \frac{D-d}{2C} \right]$$

Calculate the contact angle  $\theta$  (deg).

Then, convert it into the contact angle  $\theta$  (rad) as follows:

$$\theta \text{ (deg)} = 180^\circ - 2 \sin^{-1} \left[ \frac{D-d}{2C} \right]$$

$$\theta \text{ (rad)} = \frac{\theta \text{ (deg)}}{180} \times \pi$$

$D$  : Large pulley diameter (mm)  
 $d$  : Small pulley diameter (mm)  
 $C$  : Center distance (mm)

Calculate the traction coefficient ( $\lambda$ ).

Obtain the traction coefficient ( $\lambda$ ) by the following formula or the proportional calculation (with the use of the table at P. 25).

$$\lambda = \frac{e^{\mu \theta} - 1}{e^{\mu \theta} + 1}$$

$\mu$  : Friction coefficient of the pulley surface (0.4 normally used)  
 $\theta$  : Contact angle on the pulley (rad)

## Design Procedure 5

### Selecting the inner peripheral length of the belt

Calculate the belt length (Lp) for installation.

Obtain the inner peripheral length for installation by using the following formula or the Belt Inner Peripheral Length Nomograph (Pages 30 and 31).

$$L_p \text{ (mm)} \quad L_p = 2C + \frac{\pi(D+d)}{2} + \frac{(D-d)^2}{4C}$$

$C$  : Center distance  
 $D$  : Large pulley diameter (mm)  
 $d$  : Small pulley diameter (mm)

Calculate the belt size (Inner peripheral length) BL by using the elongation rate ( $\epsilon_0$ ).

$$BL \text{ (mm)} \quad BL = L_p \div \frac{100 + \epsilon_0}{100}$$

$\epsilon_0$  : Standard elongation rate (%)

Select a belt with the nearest size according to the obtained BL and the inner peripheral length.

## Design Procedure 6

### Selecting the belt width

Calculate the centrifugal force per unit width (Tf) applied to the belt.

$$T_f = 0.002 \times \gamma \times V^2 \times t \quad \text{(N/mm)}$$

$\gamma$  : Specific gravity (1.24 normally used)  
 $V$  : Belt speed (m/s)  
 $t$  : Belt thickness (mm)

Then, calculate the belt width (W).

$$W' = \frac{P}{(SL - T_f) \times \lambda} \quad \text{(mm)}$$

$P$  : Design tension (N)  
 $SL$  : Axial load under stable conditions (N/mm)  
 $\lambda$  : Traction coefficient

The belt length is set by 5 mm unit;

round the belt length obtained above to the nearest 5 mm.

$$\text{Belt width } W \text{ (mm)} \quad W = (\text{Width set by 5 mm unit}) \geq W'$$

## Design Procedure 7

### Calculating the required elongation rate of the belt

$$\epsilon = \epsilon_0 \times \frac{W'}{W} \quad (\%)$$

$\epsilon_0$  : Standard elongation rate (%)

# Design Calculation

## Design conditions

- (1) Type of Machine: Cross flow fan
- (2) Motor rated output: 2.2 kw
- (3) Number of revolutions of the original driving axle
- (4) Speed ratio: 1 to 2 deceleration
- (5) Center distance
- (6) Drive pulley diameter
- (7) Belt width limit: 30 mm or less
- (8) Sudden start/stop: None
- (9) Use conditions: Poor conditions not observed in indoor use

## Design Procedure 1

### Calculating the effective tension applied to the belt

- (1) Calculate the belt speed.

$$\text{Belt speed } V \text{ (m/s)} \quad V = \frac{\pi \times D \times n}{60000}$$

$$V = \frac{\pi \times 150 \times 1750}{60000}$$

$$V = 13.74 \text{ (m/s)}$$

$\pi$  : Circumference ratio  
 $D$  : Drive pulley diameter (mm)  
 $n$  : Number of revolutions of the drive pulley (r/min)

- (2) Calculate the effective tension applied to the belt.

$$\text{Effective tension } T_e \text{ (N)} \quad T_e = \frac{1000 \times P_m}{V}$$

$$T_e = \frac{1000 \times 2.2}{13.74}$$

$$T_e = 160.12 \text{ (N)} \quad P_m : \text{ Transmitted power (kW)}$$

## Design Procedure 2

### Obtaining the design tension

Obtain the transmitted power correction factor (K1) from the table (Page 24).

Transmitted power correction factor (K1) = 2.0

Then, calculate the design tension P.

$$\text{Design tension } P \text{ (N)} \quad P = T_e \times K_1 \\ = 160.12 \times 2.0 = 320.24 \text{ (N)}$$

## Design Procedure 3

### Selecting the belt type

Select the belt type "B-PB" from the Belt Type Selection Diagram (Page 25)

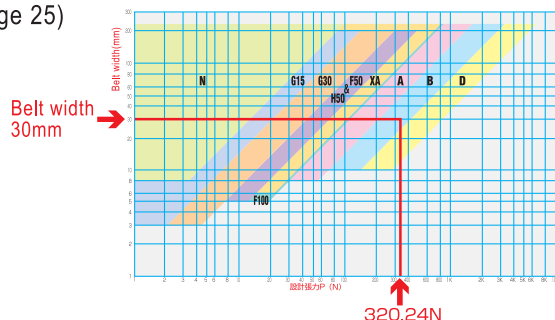

## Design Procedure 4

### Calculating the traction coefficient ( $\lambda$ )

Select the appropriate pulley diameter according to the speed ratio, the pulley limit diameter, etc.

Drive pulley diameter  $d$

Driven pulley diameter  $D$

Calculate the contact angle  $\theta$  (rad) of the belt on the pulley.

$$\theta = \pi - 2\text{SIN}^{-1} \cdot \left[ \frac{D-d}{2C} \right] \\ = \pi - 2\text{SIN}^{-1} \cdot \left[ \frac{300-150}{2 \times 500} \right] = 2.84 \text{ (rad)}$$

Or, first calculate the contact angle  $\theta$  (deg) and convert it into the contact angle  $\theta$  (rad) as follows.

$$\theta \text{ (deg)} = 180^\circ - 2\text{SIN}^{-1} \cdot \left[ \frac{D-d}{2C} \right] \\ \theta \text{ (deg)} = 180^\circ - 2\text{SIN}^{-1} \cdot \left[ \frac{300-150}{2 \times 500} \right] = 162.7 \text{ (deg)} \\ \theta \text{ (rad)} = \frac{\theta \text{ (deg)}}{180} \times \pi = \frac{162.7}{180} \times \pi = 2.84 \text{ (rad)}$$

Obtain the traction coefficient ( $\lambda$ ) by the following formula or the proportional calculation (with the use of the table at Page 25).

$$\lambda = \frac{e^{\mu\theta} - 1}{e^{\mu\theta} + 1} = \frac{e^{0.4 \times 2.84} - 1}{e^{0.4 \times 2.84} + 1} = 0.5139$$

$\mu$  : Friction coefficient of the pulley surface (0.4 normally used)

## Design Procedure 5

### Selecting the inner peripheral length of the belt

Obtain the belt length ( $L_p$ ) for use by using the Belt Inner Peripheral Length Nomograph (P. 30 and 31) or the following formula.

$$L_p = 2C + \frac{\pi(D+d)}{2} + \frac{(D-d)^2}{4C} \\ L_p = 2 \times 500 + \frac{\pi(300+150)}{2} + \frac{(300-150)^2}{4 \times 500} \\ = 1718.1 \text{ (mm)}$$

$C$  : Center distance (mm)  
 $D$  : Large pulley diameter (mm)  
 $d$  : Small pulley diameter (mm)

When using the belt B-PB, the standard elongation rate ( $\epsilon_0$ ) is 1%; calculate the belt size (Inner peripheral length BL) as follows:

$$BL = L_p \div \frac{100 + \epsilon_0}{100} \\ BL = 1718.1 \div \frac{100 + 1}{100} = 1701.1$$

Select the nearest size belt from the belt length list.  
 Selected belt size: B-PB 1700(mm)

## Design Procedure 6 Selecting the belt width

Calculate the centrifugal force per unit width (Tf) applied to the belt.

$$Tf = 0.002 \times \gamma \times v^2 \times t$$

$$Tf = 0.002 \times 1.24 \times 13.74^2 \times 1.4$$

$$= 0.655 \text{ (N/mm)}$$

$\gamma$  : Specific gravity  
(1.24 normally used)

$v$  : Belt speed (m/s)

$t$  : Belt thickness (mm)

Then, calculate the belt width (W).

$$W' = \frac{P}{(SL - Tf) \times \lambda}$$

$$= \frac{320.24}{(29.4 - 0.655) \times 0.5139}$$

$$= 21.7 \text{ (mm)}$$

$P$  : Design tension (N)  
 $SL$  : Axial load under stable conditions (N/mm)

$\lambda$  : Traction coefficient

The belt length is set by 5 mm unit;  
select the belt width of 25 mm.

$$\text{Belt width } W \text{ (mm)} : W = 25 \text{ mm} \geq 21.7 \text{ mm}$$

## Design Procedure 7 Calculating the required elongation rate of the belt ( $\epsilon$ )

Calculate the required elongation rate ( $\epsilon$ ).

$$\epsilon = \epsilon_0 \times \frac{W'}{W} = 1 \times \frac{21.7}{25} = 0.87 \text{ (\%)}$$

$\epsilon_0$  : Standard elongation rate (%)

The following is the result of selection of the belt.

- Belt type : SE-B-PB
- Belt size : 25<sup>W</sup>mm×1700<sup>L</sup>mm×1.4<sup>T</sup>mm
- Drive pulley :  $\phi$  150mm
- Driven pulley :  $\phi$  300mm
- Required belt elongation rate : 0.9%

MEMO

# Formulas and Conversion Table

Item	Symbol	Unit	Formula	Remarks
Belt speed	V	m/s	$V = \frac{\pi \times D \times n}{60000}$	D : Drive pulley diameter (mm) n : Number of revolutions of the drive pulley (r/min)
Number of revolutions	n	r/min	$n = \frac{60000 \times V}{\pi \times D}$	
Belt installation length (Open belt)	Lp	mm	$L_p \doteq 2C + \frac{\pi(D+d)}{2} + \frac{(D-d)^2}{4C}$	D : Large pulley outer diameter (mm) d : Small pulley outer diameter (mm)
Center distance	C	mm	$C \doteq \frac{b + \sqrt{b^2 - 8(D-d)^2}}{8}$	b = 2Lp - π (D+d)
Small pulley contact angle	θ	(deg)	$\theta \text{ (deg)} = 180^\circ - 2 \sin^{-1} \cdot \left[ \frac{D-d}{2C} \right]$	D : Large pulley outer diameter (mm) d : Small pulley outer diameter (mm) C : Center distance (mm)
		(deg)	$\theta \text{ (deg)} \doteq 180 - \left[ \frac{57.3 \times (D-d)}{C} \right]$	
		(rad)	$\theta \text{ (rad)} = \theta \text{ (deg)} \div 180 \times \pi$	
Traction coefficient	λ		$\lambda = \frac{e^{\mu\theta} - 1}{e^{\mu\theta} + 1}$	μ : Friction coefficient θ : (rad)
Number of revolutions of the motor	n	r/min	$n = \frac{120 \times V_N}{P_o}$	V <sub>N</sub> : Power frequency P <sub>o</sub> : Number of motor poles

Item	Symbol	Unit	Formula	Remarks
Effective tension	Te	N	$T_e = \frac{1000 \times P_m \text{ (kW)}}{V}$	P <sub>m</sub> : Transmitted power (kW or W) V : Belt speed
			$T_e = \frac{P_m \text{ (W)}}{V}$	
			$T_e = \frac{2000 \times T_r \text{ (N·m)}}{D}$	T <sub>r</sub> : Torque (N·m or N·mm) D : Pulley diameter (mm)
			$T_e = \frac{2 \times T_r \text{ (N·mm)}}{D}$	
			$T_e = m \times \alpha$	m : Mass (kg) α : Acceleration/deceleration speed
Torque	Tr	N·m	$T_r = \frac{9550 \times P_m \text{ (kW)}}{n}$	n : Number of revolutions
			$T_r = \frac{9.55 \times P_m \text{ (W)}}{n}$	
			$T_r = \frac{J \times (n_1 - n_2)}{9.55 \times t}$	J : Moment of inertia n <sub>1</sub> -n <sub>2</sub> : Difference in number of revolutions t : Acceleration/deceleration time GD <sup>2</sup> : Flywheel effect
			$T_r = \frac{GD^2 \times (n_1 - n_2)}{38.2 \times t}$	
Transmitted power	Pm	W or kW	$P_m \text{ (kW)} = \frac{T_e \times V}{1000}$	T <sub>e</sub> : Effective tension V : Belt speed
			$P_m \text{ (W)} = T_e \times V$	
			$P_m \text{ (kW)} = \frac{T_r \times n}{9550}$	T <sub>r</sub> : Torque
			$P_m \text{ (W)} = \frac{T_r \times n}{9.55}$	



# Calculating Belt Inner Peripheral Length

## Calculating the inner peripheral length of the belt

In the last step of designing the belt, obtain the inner peripheral length of the belt by using the Belt Inner Peripheral Length Nomograph (Page 31).

### <Calculation>

Belt type	: XA-PA
Standard elongation rate	: 1%
Center distance	: 150mm
Small pulley diameter	: $\phi 30$ mm
Large pulley diameter	: $\phi 50$ mm

First, add "Small pulley diameter" to "Large pulley diameter" as follows:

$$d+D=30+50=80$$

Read the value of the inner peripheral length that is on the line connecting the center distance (150 mm) and "d + D" (80 mm).

$$\text{Installation inner peripheral length } L_p \text{ (mm)} \quad L_p = \text{Approx. } 425 \text{ mm}$$

The above value is the approximate installation inner peripheral length. Therefore obtain the required inner peripheral length by dividing the above value by elongation of the belt.

$$\begin{aligned} \text{Inner peripheral length of the belt } BL \text{ (mm)} \quad BL &= \text{Installation inner peripheral length} \div \left( \frac{\text{Elongation rate (\%)}}{100} \right) \\ &= 425 \div 1.01 \\ &= 420.8 \text{ mm} \end{aligned}$$

Select the nearest inner peripheral length (420 mm) from the List of Inner Peripheral Lengths.

When using this Belt Inner Peripheral Length Nomograph, it is hard to read fractional values and if the speed ratio is high (1: 5 or more), a margin of error becomes large. In such a case, calculate the belt inner peripheral length by the following formula.

When calculating the belt length for multi axial power transmission, inform us of the pulley diameter and the coordinate; we will calculate the belt length.

$$\text{Installation inner peripheral length } L_p \text{ (mm)} \quad L_p = 2C + \frac{\pi (D+d)}{2} + \frac{(D-d)^2}{4C}$$

C : Center distance (mm)  
D : Large pulley diameter (mm)  
d : Small pulley diameter (mm)  
 $\pi$  : Circumference ratio

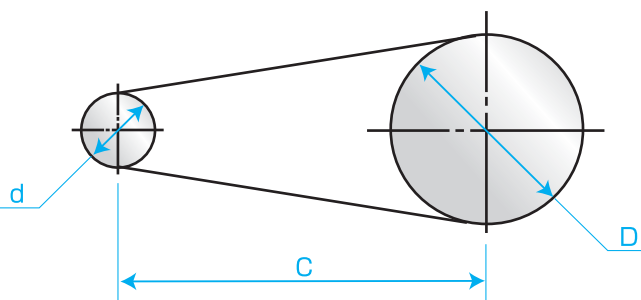

# Belt Inner Peripheral Length Nomograph

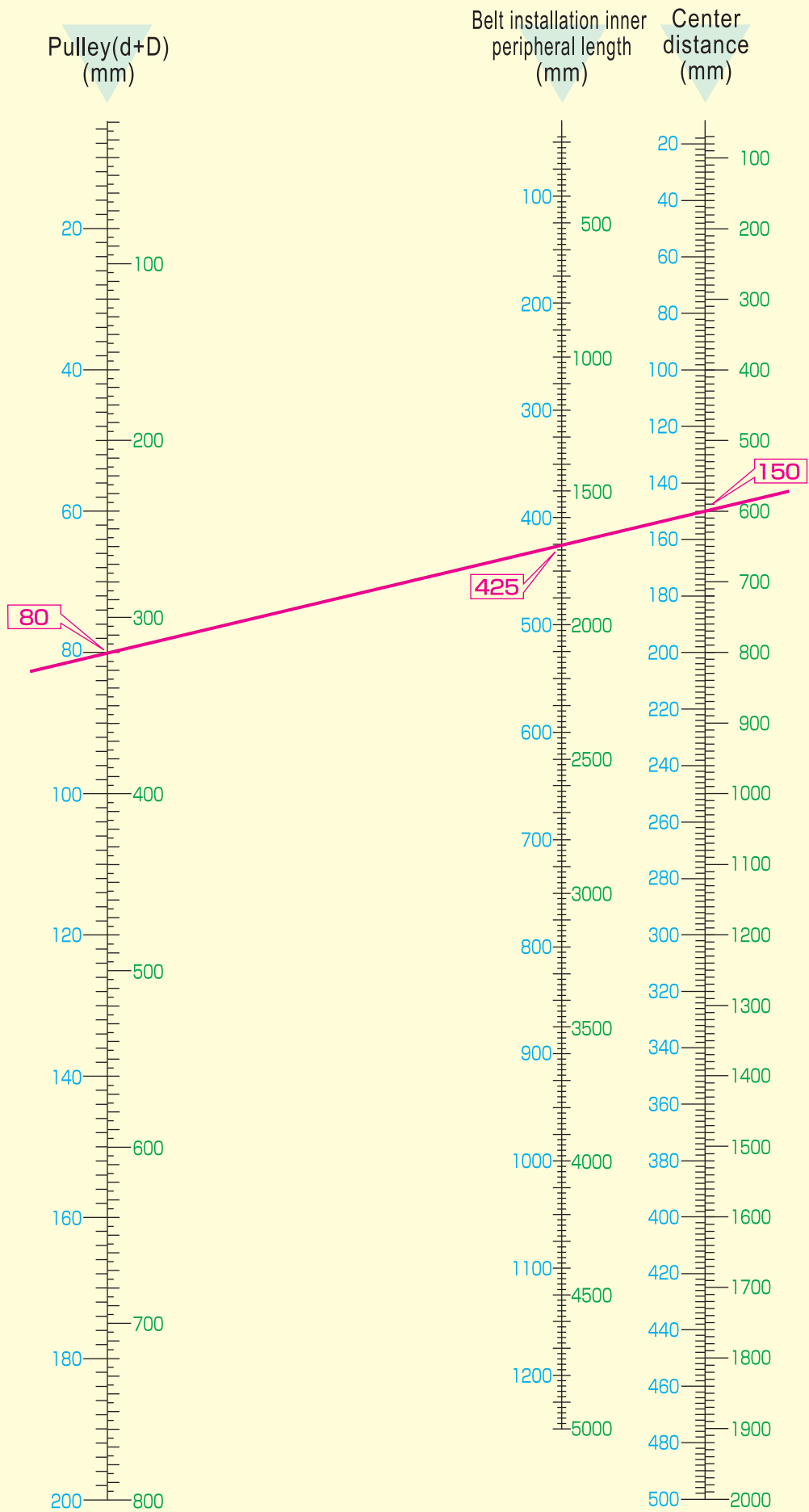

# Flat Pulley

Unlike a V-belt, a flat belt, which runs on a pulley surface, has nothing to control its movement in the width direction. Therefore, it is necessary to process the pulley to a shape of “crown”, where the center diameter is larger than the diameters on both sides.

Due to the crown processing, difference in speed occurs on the surface of the revolving pulley. When the pulley center diameter is larger, the belt stably runs on the pulley center where the belt speed is high. When the belt and the pulley skid for any cause, speed difference does not occur and the crown effect is not achieved. As a result, the belt deflects from the pulley.

Normally, the pulley is processed to make an arch (crown). (When the pulley is wider, it may be processed to make a trapezoidal shape.)

As a curvature radius becomes larger, the belt tends to run stably. On the other hand, as the curvature radius becomes smaller, the stress distribution of the belt becomes abnormal, causing shortening of the belt life or decrease in transmitted power.

Select an appropriate crown of pulley depending on the type, width and use of the belt.

## Recommended Pulley Shape

### 1. Pulley Width

Make the pulley width larger than the belt width.  
Obtain the pulley width by the following formula.

$$b_p \geq 1.15 \times b + 2 \text{ (mm)}$$

$b_p$  : Pulley width  
 $b$  : Belt width

### 2. Crown Shape

Select an appropriate crown shape depending on the use and the pulley width.

#### 1 For power transmission

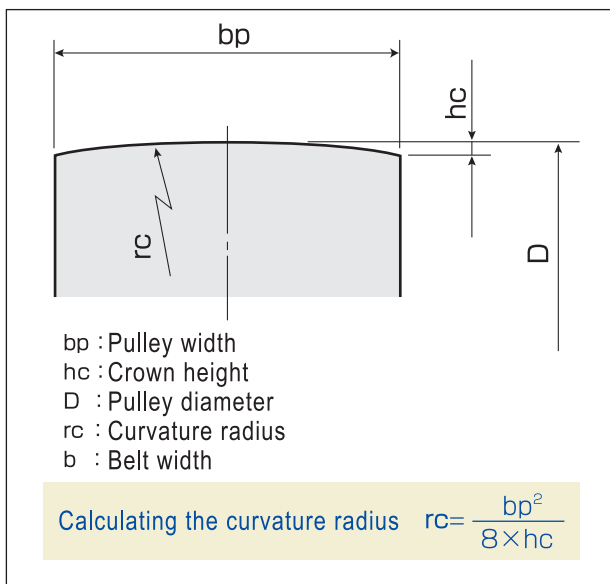

#### 2 For large-width conveyance

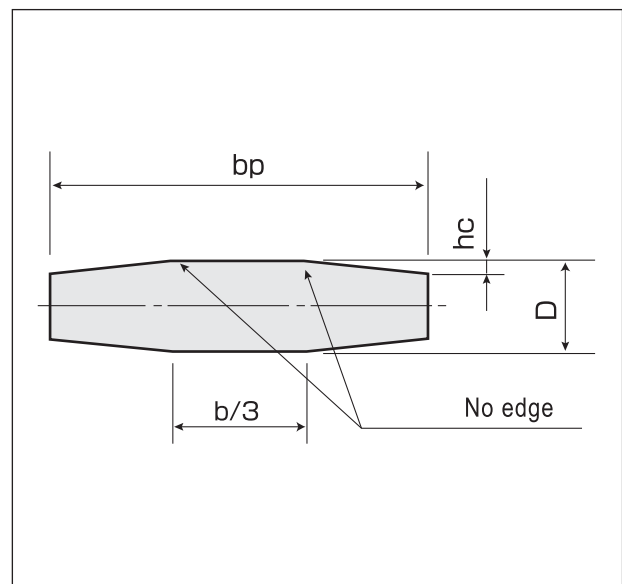

Standard Crown Height for Power Transmission and Large-Width Conveyance

(mm)

Pulley diameter (D)		$\phi 5$	$\phi 10$	$\phi 20$	$\phi 30$	$\phi 50$	$\phi 60$	$\phi 80$	$\phi 100$ or more
Crown height (hc)	Standard	0.10	0.12	0.13	0.14	0.17	0.20	0.24	$D \times 0.003$
	Upper limit	0.16	0.18	0.20	0.22	0.28	0.32	0.40	$D \times 0.005$

### 3 For pinching conveyance

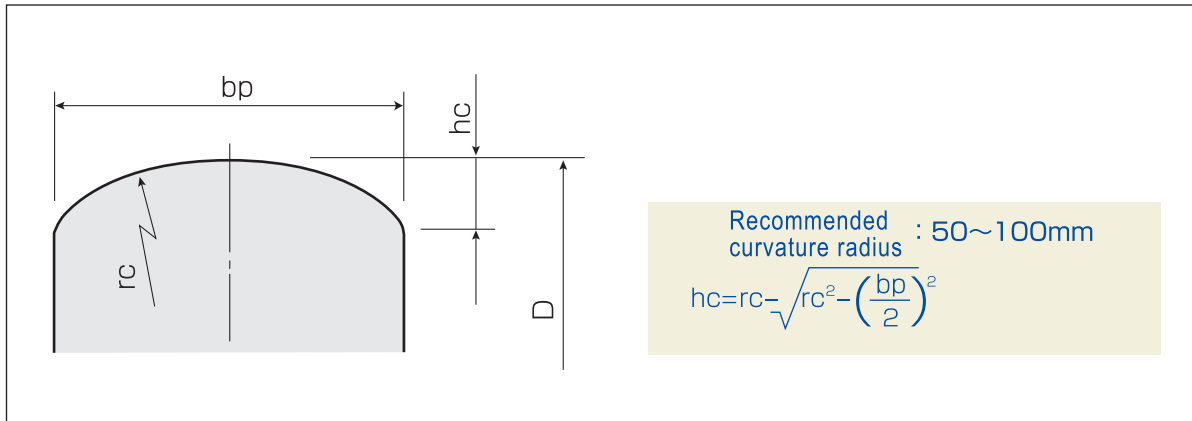

#### ● Remarks

The crown height for power transmission and large-width conveyance and the recommended curvature radius mentioned above, which are obtained from performances and experiments, are not the specified values but the reference values.

If the pulley width is larger (50 mm or more) in case of pinching conveyance, the curvature radius may become too small to fit the belt. (In such a case, consult us.)

Use an abrasion-resistant belt with the running surface finish of 1.5 to 6S. When using an aluminum pulley, treat its surface with hard alumite, etc. to prevent abrasion.

Normally, the crown becomes more effective as it becomes higher. However, if the crown becomes excessively high, the belt may not fit the crown, resulting in lack of transmission capacity and worse running conditions.



#### **Do not attach flanges to the pulley.**

When the flanges are attached to the pulley, the belt gets caught up on them in most cases, resulting in fatal damage to the belt.

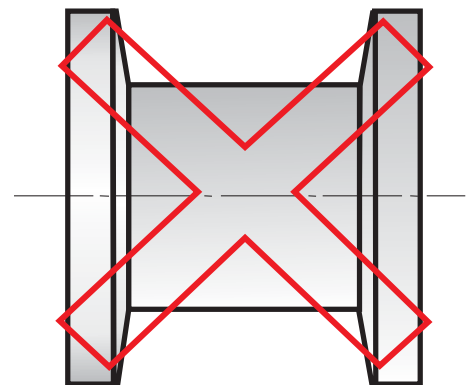

# For Correct Use

## Precautions for use

### ■ Installation Tension

The flat belt is a friction transmission belt. For power transmission, the belt requires an appropriate initial tension (installation tension). Excessively low installation tension on the belt may cause skidding and deflection; excessively high tension may cause shortening of the belt life and damage to the bearing. Select an appropriate belt depending on the load and use and apply an appropriate tension to the belt.

### Measuring the installation tension

#### ● Sonic tensiometer

Previously, we have applied installation tensions to the belts from our experience. As a result, the tension values varied widely. As a result, such an inappropriate installation tension was one of the causes of the mechanical troubles.

The sonic tensiometer shows the accurate tension value by calculating the natural vibration frequency proportional to the tension of the belt span.



Sonic Tensiometer U-507

#### ● Tension Mark System

Put tension marks on two locations of the belt under no-tension condition. While measuring the distance between the tension marks, stretch the belt to obtain the specified elongation rate. Rotate the belt once or twice to stretch it uniformly and check the tension marks.

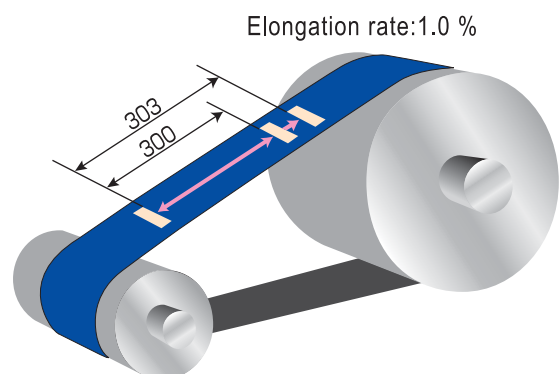

## ■ Tension Mechanism

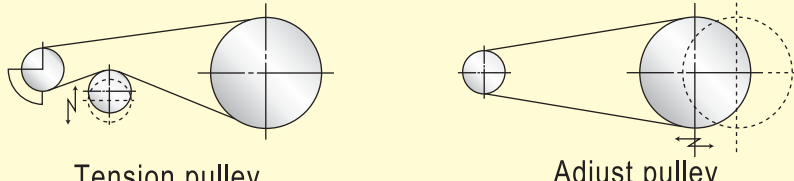
Belt Series	Tension Mechanism
XA, A, B, D, GS,	 <p>As a rule, a tension pulley or an adjusting gap is required to apply tension to the belt. The approximate adjusting gap is <math>\pm</math> (Belt length x 0.01).</p>
F50, F100	Normally, you can use the belt in a layout with the fixed center distance. Due to tolerance, however, the load applied to the bearing may become large. It is recommended to set the adjusting gap.
G15, G30	Suitable for the layout where the center distance is fixed; the tension mechanism is not needed.
N	Highly stretchable; you can easily attach this belt in a complicated layout without a tension mechanism.

## ■ Recommended Elongation Rate

	XA, A, B, D	GS	F50, F100	G15, G30	N
Standard elongation rate	1.0%	0.3%	2.0%	2.0%	5.0%
Elongation rate range	0.5 to 1.0%	0.2 to 0.4%	1.0 to 3.0%	1.0 to 4.0%	3.0 to 7.0%

Note: When attaching the belt with the center distance fixed, choose the standard elongation rate or the medium value of the elongation rate range to select the belt type. Set tolerance of the inner peripheral length within the elongation rate range.

## ■ Belt Surface

As a pulley surface, use a surface with higher belt friction coefficient.

\*[Example] SBU Type: Use a polished surface as a pulley surface.

LBU Type: Use a glossy surface as a pulley surface.



## ■ Others

Package SEB in a polyethylene bag used for shipping and store it in a cool dark place free from direct sunlight. Lightly wipe the belt with waste cloth impregnated with low-volatile alcohol. Then wipe it with dry waste cloth.

# Measures against the Following Problems

## Troubleshooting

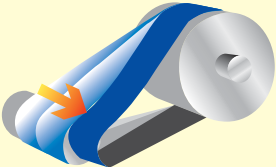
### Power Transmission

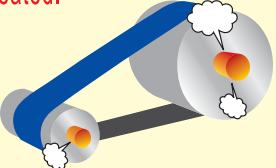
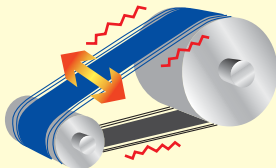
Failure	Failure Diagnosis	Troubleshooting
<p>The belt comes off the pulley.</p> 	The belt deviates at start-up and then returns to normal operation.	<ul style="list-style-type: none"> <li>● The starting torque is too high; further tighten the belt if possible.</li> <li>● Change the belt type to a high-strength one.</li> <li>● Lower the starting load.</li> </ul>
	Normal when the load is low; the belt comes off when the load becomes high.	<ul style="list-style-type: none"> <li>● The load is higher, compared with the belt effective tension; further tighten the belt if possible.</li> <li>● Change the belt type to a high-strength one.</li> <li>● Lower the starting load.</li> </ul>
	The belt comes off even when the load is low.	<ul style="list-style-type: none"> <li>● Correct pulley parallelism.</li> <li>● Check that the pulley does not bend.</li> <li>● Check that the belt is stretched at the specified elongation rate.</li> <li>● Correct the pulley shape.</li> </ul>
<p>The specified speed is not achieved.</p> 	Even when further tightening the belt, the revolution speed does not increase.	<ul style="list-style-type: none"> <li>● Measure the pulley diameter. When the speed ratio is large, add the pitch line position to the pulley diameter.</li> <li>● Measure revolution speed again.</li> </ul>
<p>The bearings are excessively heated.</p> 	Check for excessive tension of the belt.	<ul style="list-style-type: none"> <li>● When the belt is stretched beyond the specified elongation rate, lower the rate.</li> <li>● When the belt width is too large compared with the load, lower the width.</li> </ul>
	The belt tension is appropriate.	<ul style="list-style-type: none"> <li>● Select appropriate bearings according to the bearing allowable load and revolution speed</li> <li>● Check for shortage of lubricating oil.</li> </ul>
<p>Belt deflection</p> 	The belt deflects to the pulley axis. (Snaking)	<ul style="list-style-type: none"> <li>● Correct the pulley shape.</li> <li>● Check that the belt does not bend locally.</li> <li>● Remove foreign mater from the belt if any.</li> </ul>
	The belt deflects perpendicularly to the direction of the pulley axis. (Waving)	<ul style="list-style-type: none"> <li>● The vibration frequency of the machine resonates with that of the natural vibration frequency of the belt; change the belt tension.</li> </ul>

### Complicated Layout (Pinching conveyance, etc.)

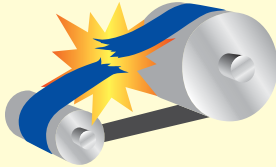

<p>The belt breaks</p> 	The belt breaks at the early stage of operation.	<ul style="list-style-type: none"> <li>● Check that the belt is not excessively stretched for installation or the belt edge is not damaged by the flame edge.</li> </ul>
	The belt moves to one side and then breaks. Generally, the belt breaks when it winds around the pulley or contacts the frame. Investigate the cause.	<ul style="list-style-type: none"> <li>● Check that the pulley shape is correct.</li> <li>● Remove the pulley flange.</li> <li>● Check that the gap between the pulleys is not small and the pulleys do not squeeze together.</li> <li>● Adjust parallelism of the pulleys.</li> <li>● Check that the pulley shaft does not bend.</li> <li>● Check that the belt is stretched at the specified elongation rate.</li> </ul>

# For Safe Use of Products

✳️ **Before use, carefully read and follow the safety precautions below.**

For safe use, this instruction manual and the product use various symbols and signal words. After fully understanding their meanings, read the safety precautions and follow the instructions.

■ Improper use ignoring the symbols and the signal words may result in the following risks.

Symbol and Signal Word	Severity of Risk
 <b>DANGER</b>	Indicates matters that may lead to imminent risk of death or serious injury if ignored or incorrectly handled.
 <b>WARNING</b>	Indicates matters that may lead to death or serious injury if ignored or incorrectly handled.
 <b>CAUTION</b>	Indicates matters that may lead to injury and physical damage if ignored or incorrectly handled.

## 1 Function and Performance

### **DANGER**

- Do not use the belt as hoisting or towing equipment.

### **WARNING**

- Do not use the belt beyond the acceptable ranges specified in the Catalogue.
- When fire and malfunction of the control device are expected due to static electricity generating in the transmission device, use an antistatic belt. Set a neutralization apparatus in the transmission device.
- Do not use the belt for conveying unpackaged food.

## 2 Storage and Shipping

### **WARNING**

- Keep fire away.

### **CAUTION**

- When storing and shipping the belts, do not distort them excessively.
- Store the belts in a well-ventilated, low-humidity place free from direct sunlight.  
The recommended storage temperature is – 10 to + 30°C.
- Store the belts in the shipping packages.

## 3 Installation and Daily Use

### **DANGER**

- Be sure to put a safety cover over the rotating part including the belt; hair, gloves or clothes may get caught in the belt pulley.
- Before maintenance, inspection or replacement, be sure to turn off the switch and check that the machine stops.

### **WARNING**

- When cleaning the belt, do not use chemicals harmful to humans.

### **CAUTION**

- After replacing the belt with a new one, perform a test operation to adjust elongation rate and traveling of the belt.
- When abnormal noise, snaking, deviation, slipping, etc. occur, stop the belt immediately for inspection.

## 4 Handling Used Belts

### **WARNING**

- Do not leave the belts near fire.

### **CAUTION**

- Do not burn used belts; harmful gasses may be generated.
- Lawfully dispose of the used belts as industrial waste.